

# OPERATION & MAINTENANCE

## *Affinity YDL Series*

 **YORK**<sup>®</sup>

R-454B

60Hz

OMV5-0005Y



All Affinity YDL Series models are safety listed and conforms to UL STDS 60335-1 & 60335-2-40 / Certified to CSA STDSC22.2 60335-1 & 60335-2-40 through ETL. Performance listed with AHRI in accordance with ASHRAE/ANSI/AHRI/ISO Standard 13256-1 (Models: 084, 096, 120) Performance verified in accordance with ASHRAE/ANSI/AHRI/ISO Standard 13256-1 (Models: 150, 180, 240, 300, 360)



## WARNING



**WARNING:** Before performing service or maintenance operations on the system, turn off main power switches to the unit. Electrical shock could cause serious personal injury.

**WARNING:** All products are designed, tested, and manufactured to comply with the latest publicly released and available edition of UL 60335-2-40 for electrical safety certification. All field electrical connections must follow the National Electrical Code (NEC) guide standards and / or any local codes that may be applicable for the installation.

**WARNING:** Only factory authorized personnel are approved for startup, check test and commissioning of this unit.

**INSTALLER:** Please take the time to read and understand these instructions prior to any installation. Installer must give a copy of this manual to the owner.

## Definition of Warnings and Symbols

 <b>DANGER</b>	Indicates a situation that results in death or serious injury.
 <b>WARNING</b>	Indicates a situation that could result in death or serious injury.
 <b>CAUTION</b>	Indicates a situation that could result in minor or moderate injury.
<b>NOTICE</b>	Indicates a situation that could result in equipment or property damage.

## For the User



## WARNING

This appliance is not intended for use by persons (including children) with reduced physical, sensory, or mental capabilities, or lack of experience and knowledge, unless they have been given supervision or instruction concerning use of the appliance by a person responsible for their safety.

Children should be supervised to ensure that they do not play with the appliance.

Keep this manual in a safe place in order to provide your service personnel with necessary information.

## NOTICE

**NOTICE:** To avoid equipment damage, do not leave the system filled in a building without heat during cold weather, unless adequate freeze protection levels of antifreeze are used. Heat exchangers do not fully drain and will freeze unless protected, causing permanent damage.

# Table of Contents

## UNIT OVERVIEW

Nomenclatures	6
AHRI Data	7
Electrical Availability	9
Physical Data	10
Dimensional Data	11
Electrical Data	19
Fuse Replacement	20
Unit Weight	20

## OPERATING PRINCIPLES

Blower Performance Data	21
Antifreeze Corrections	25
Correction Factor Tables	26
Water Quality	27
Operating Limits and Parameters	28
Operation Logic Data Table	29
Pressure Drop	30
Aurora Controls Operation	31
Refrigerant Circuit Guideline	40

## SERVICE AND TROUBLESHOOTING

System Cleaning and Flushing	41
Open Loop Ground Water Systems	42
Freeze Detection	42
Reference Calculations and Legend	43
Compressor and Thermistor Resistance	44
Troubleshooting Checklist	45
Control Board Troubleshooting Steps	46
Control Board Troubleshooting Flow Charts	48
Control Board Signals	63
Jumping the Control Board	66
Preventative Maintenance	69
Replacement Procedures	69
Troubleshooting	70
Decommissioning	72
Refrigerant Recovery	73
Refrigerant Removal and Evacuation	73
Charging Procedures	74

REVISION GUIDE	75
----------------	----

## General Installation Information

**NOTICE: Do not store or install units in corrosive environments or in locations subject to temperature or humidity extremes. Corrosive conditions and high temperature or humidity can significantly reduce performance, reliability, and service life.**

**NOTICE: A minimum of 24 in. clearance should be allowed for access to front access panel.**

**NOTICE: To avoid equipment damage, DO NOT use these units as a source of heating or cooling during the construction process. The mechanical components and filters can quickly become clogged with construction dirt and debris, which may cause system damage and void product warranty.**

### For the Installer

If you are NOT sure how to install or operate the unit, contact your dealer.

Installing and servicing air conditioning and heating equipment can be hazardous due to system pressure and electrical components. Only trained and qualified service personnel should install, repair or service heating and air conditioning equipment. When working on heating and air conditioning equipment, observe precautions in the literature, tags and labels attached to the unit and other safety precautions that may apply.

This manual contains specific information about the required qualification of the working personnel for maintenance, service and repair operations. Every working procedure that affects safety means shall only be carried out by competent persons.

Examples for such working procedures are:

- breaking into the refrigerating circuit;
- opening of sealed components or ventilated enclosures.

Follow all safety codes. Wear safety glasses and work gloves. Use quenching cloth for brazing operations. Have fire extinguisher available for all brazing operations. Follow all procedures to remain in compliance with national gas regulations.

Prior to beginning work on systems containing FLAMMABLE REFRIGERANTS, safety checks are necessary to ensure that the risk of ignition is minimized. Work shall be undertaken under a controlled procedure so as to minimise the risk of a flammable gas or vapor being present while the work is being performed. All maintenance staff and others working in the local area shall be instructed on the nature of work being carried out. Work in confined spaces shall be avoided.

The area shall be checked with an appropriate refrigerant detector prior to and during work, to ensure the technician is aware of potentially toxic or flammable atmospheres. Ensure that the leak detection equipment being used is suitable for use with all applicable refrigerants, i.e. non-sparking, adequately sealed or intrinsically safe.

If any hot work is to be conducted on the refrigerating equipment or any associated parts, appropriate fire extinguishing equipment shall be available to hand. Have a dry powder or CO2 fire extinguisher adjacent to the charging area.

No person carrying out work in relation to a REFRIGERATING SYSTEM which involves exposing any pipe work shall use any sources of ignition in such a manner that it may lead to the risk of

fire or explosion. All possible ignition sources, including cigarette smoking, should be kept sufficiently far away from the site of installation, repairing, removing and disposal, during which refrigerant can possibly be released to the surrounding space. Prior to work taking place, the area around the equipment is to be surveyed to make sure that there are no flammable hazards or ignition risks. "No Smoking" signs shall be displayed.

Where electrical components are being changed, they shall be fit for the purpose and to the correct specification. At all times the manufacturer's maintenance and service guidelines shall be followed. If in doubt, consult the manufacturer's technical department for assistance.

The following checks shall be applied to installations using FLAMMABLE REFRIGERANTS:

- the actual REFRIGERANT CHARGE is in accordance with the room size within which the refrigerant containing parts are installed;
- the ventilation machinery and outlets are operating adequately and are not obstructed;
- if an indirect refrigerating circuit is being used, the secondary circuit shall be checked for the presence of refrigerant;
- marking to the equipment continues to be visible and legible. Markings and signs that are illegible shall be corrected;
- refrigerating pipe or components are installed in a position where they are unlikely to be exposed to any substance which may corrode refrigerant containing components, unless the components are constructed of materials which are inherently resistant to being corroded or are suitably protected against being so corroded.

### WARNING

**If the appliance locks out on E5: FREEZE PROTECTION FP1. The appliance must set for 5 hours before being restarted.**

### Instructions for Equipment Using R-454B Refrigerant

### WARNING

- **Do NOT pierce or burn**
- **Do NOT use means to accelerate the defrosting process or to clean the equipment, other than those recommended by the manufacturer**
- **Be aware that refrigerants may not contain an odor**

### WARNING

- **The Appliance should be stored so as to prevent mechanical damage and in a room without continuously operating ignition sources (example: open flames, an operating gas appliance or an operating electric heater)**

## General Installation Information

### WARNING

**Ventilated Area:** ensure that the area is in the open or that it is adequately ventilated before breaking into the system of conducting any hot work. A degree of ventilation should continue during the period that the work is carried out. The ventilation should safely disperse any released refrigerant and preferably expel it. Keep ventilation area clear of obstructions!

### WARNING

**Do NOT use potential sources of ignition in searching for or detection of refrigerant leaks. A halide torch (or any other detector using a naked flame) shall not be used.**

The following leak detection methods are deemed acceptable for all refrigerant systems. Electronic leak detectors may be used to detect refrigerant leaks but, in the case of FLAMMABLE REFRIGERANTS, the sensitivity may not be adequate, or may need re-calibration. (Detection equipment shall be calibrated in a refrigerant-free area.) Ensure that the detector is not a potential source of ignition and is suitable for the refrigerant used. Leak detection equipment shall be set at a percentage of the LFL. of the refrigerant and shall be calibrated to the refrigerant employed, and the appropriate percentage of gas (25 % maximum) is confirmed. Leak detection fluids are also suitable for use with most refrigerants but the use of detergents containing chlorine shall be avoided as the chlorine may react with the refrigerant and corrode the copper pipe-work. NOTE Examples of leak detection fluids are bubble method, fluorescent method agents If a leak is suspected, all naked flames shall be removed/extinguished. If a leakage of refrigerant is found which requires brazing, all of the refrigerant shall be recovered from the system, or isolated (by means of shut off valves) in a part of the system remote from the leak. Removal of refrigerant shall follow the procedure outlined in this manual.

## Installation Site

This equipment has been evaluated to be installed up to a maximum altitude of 3000m (9843ft) and should not be installed at an altitude greater than 3000m. For installation only in locations not accessible to the general public.

### WARNING

**For appliances using A2L refrigerants connected via an air duct system to one or more rooms, only auxiliary devices approved by the appliance manufacturer or declared suitable with the refrigerant shall be installed in connecting ductwork. The manufacturer shall list in the instructions all approved auxiliary devices by manufacturer and model number for use with the specific appliance, if those devices have a potential to become an ignition source.**

## Installation Space Requirements

NOTE: Equipment with refrigerant charge less than 63 oz does not have a minimum floor area requirement and does not require a refrigerant leak detection sensor. The sensor might be added as a feature.

### WARNING

**Equipment containing R-454B refrigerant shall be installed, operated, and stored in a room with floor area larger than the area defined in the “Minimum Floor Area” chart based on the total refrigerant charge in the system. This requirement applies to indoor equipment with or without a factory refrigerant leakage sensor.**

### CAUTION

**It is not recommended to use a potable water source for this equipment water supply.**

### WARNING

**This equipment comes with a factory installed Refrigerant Detection Device which is capable of determining it's specified end-of-life and replacement instructions. Refrigerant sensors for refrigerant detection systems shall only be replaced with sensors specified by the appliance manufacture.**

### WARNING

**Take sufficient precautions in case of refrigerant leakage. If refrigerant gas leaks, ventilate the area immediately.**  
**POSSIBLE RISKS: Excessive refrigerant concentrations in a closed room can lead to oxygen deficiency**

### WARNING

**ALWAYS recover the refrigerant. Do NOT release them directly into the environment. Follow handling instructions carefully in compliance with national regulations.**

### WARNING

**Check that cabling will not be subject to wear, corrosion, excessive pressure, vibration, sharp edges or any other adverse environmental effects. The check shall also take into account the effects of aging or continual vibration from sources such as compressors or fans.**

# Nomenclatures

## Y5AV120BD3\*N5CTLAANN31NSSS

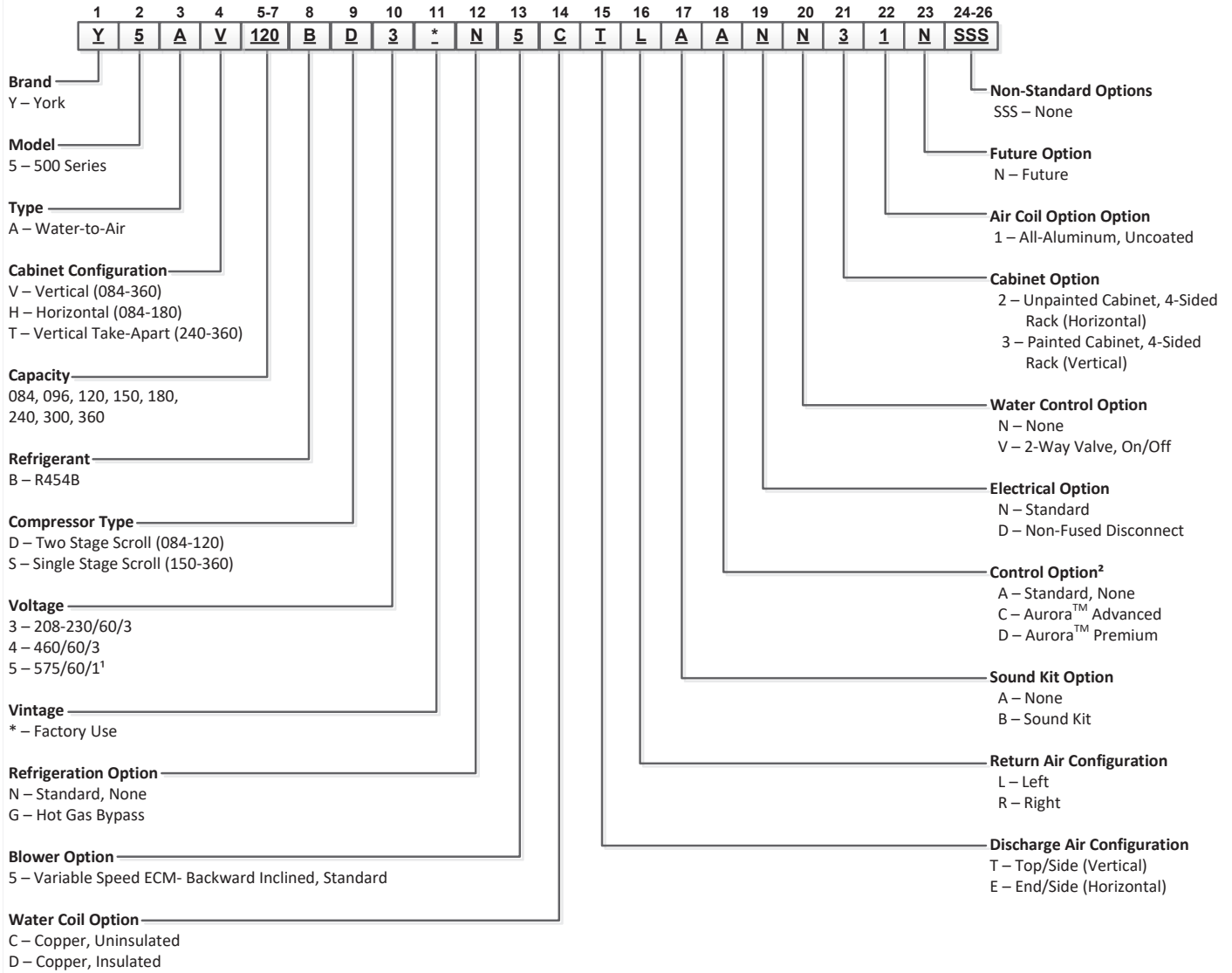

Note:  
 1- 575V option requires a factory installed stepdown transformer.  
 2- Premium Controls Option includes electronic expansion valve (EEV).

# AHRI Data

**Vertical**  
**AHRI/ASHRAE/ISO 13256-1**  
**English (IP) Units**

Model	Capacity Modulation	Flow Rate		Water Loop Heat Pump				Ground Water Heat Pump				Ground Loop Heat Pump			
				Cooling EWT 86°F		Heating EWT 68°F		Cooling EWT 59°F		Heating EWT 50°F		Cooling Brine Full Load 77°F Part Load 68°F		Heating Brine Full Load 32°F Part Load 41°F	
		gpm	cfm	Capacity Btuh	EER Btuh/W	Capacity Btuh	COP	Capacity Btuh	EER Btuh/W	Capacity Btuh	COP	Capacity Btuh	EER Btuh/W	Capacity Btuh	COP
084	Full	21	2500	86,000	15.0	105,000	5.0	97,000	21.0	86,000	4.4	90,000	17.0	69,000	3.8
	Part	14	1750	58,000	16.0	68,000	5.2	67,000	28.0	56,000	4.5	64,000	23.5	49,500	4.0
096	Full	24	2800	95,000	15.0	120,000	5.0	105,000	20.0	97,000	4.4	98,000	16.5	76,000	3.6
	Part	16	1900	63,000	15.7	76,000	5.2	73,000	26.0	62,000	4.5	69,000	21.5	54,000	3.8
120	Full	30	3600	120,000	15.0	139,500	5.0	135,000	21.0	111,000	4.0	123,500	16.5	89,000	3.5
	Part	20	2400	78,000	16.0	88,000	5.1	92,000	26.5	71,000	4.1	87,000	22.5	62,000	3.6
150	Full	36	4500	145,000	15.0	140,000	4.3	156,000	20.0	120,000	4.1	150,000	16.6	90,000	3.2
	Part	18	2300	70,000	16.0	67,000	4.6	80,000	21.0	55,000	4.2	75,000	19.0	50,000	3.3
180	Full	45	5200	175,000	13.5	185,000	4.3	190,000	19.0	152,000	3.8	180,000	15.5	122,000	3.2
	Part	28	2800	87,000	14.5	90,000	4.4	95,000	22.0	71,000	4.0	92,000	19.0	66,000	3.3
240	Full	60	7500	245,000	17.0	255,000	4.8	270,000	25.0	212,000	4.2	245,000	19.0	150,000	3.3
	Part	35	5400	132,000	18.0	118,000	5.7	150,000	30.0	91,000	4.7	146,000	24.0	84,000	4.5
300	Full	75	9000	300,000	14.5	340,000	4.2	350,000	21.0	255,000	3.5	317,000	16.7	196,000	3.7
	Part	40	5500	140,000	16.0	140,000	4.3	155,000	22.0	110,000	3.6	153,000	17.5	97,000	3.8
360	Full	90	9900	350,000	12.0	385,000	3.4	398,000	17.0	325,000	3.2	375,000	14.0	260,000	2.8
	Part	45	5500	152,000	12.1	165,000	3.6	180,000	18.0	135,000	3.3	172,000	15.0	118,000	3.0

5/7/24

Cooling capacities based upon 80.6°F DB, 66.2°F WB entering air temperature

Heating capacities based upon 68°F DB, 59°F WB entering air temperature

All ratings based upon 208V operation

Models 084-120 are rated and certified in accordance with ISO/AHRI/ASHRAE 13256-1

Models 150-360 are rated in accordance with ISO/AHRI/ASHRAE 13256-1 but are not certified since their capacity exceeds the scope of the AHRI program.

**Horizontal**  
**AHRI/ASHRAE/ISO 13256-1**  
**English (IP) Units**

Model	Capacity Modulation	Flow Rate		Water Loop Heat Pump				Ground Water Heat Pump				Ground Loop Heat Pump			
				Cooling EWT 86°F		Heating EWT 68°F		Cooling EWT 59°F		Heating EWT 50°F		Cooling Brine Full Load 77°F Part Load 68°F		Heating Brine Full Load 32°F Part Load 41°F	
		gpm	cfm	Capacity Btuh	EER Btuh/W	Capacity Btuh	COP	Capacity Btuh	EER Btuh/W	Capacity Btuh	COP	Capacity Btuh	EER Btuh/W	Capacity Btuh	COP
H084	Full	21	2500	81,000	14.3	99,700	4.8	92,100	20.0	81,700	4.2	85,500	16.2	65,500	3.6
	Part	14	1750	55,100	15.2	64,600	4.9	63,600	26.6	53,200	4.3	60,800	22.3	47,000	3.8
H096	Full	24	2800	90,250	14.3	114,000	4.8	99,700	19.0	92,100	4.2	93,100	15.7	72,200	3.4
	Part	16	1900	59,800	14.9	72,200	4.9	69,300	24.7	58,900	4.3	65,500	20.4	51,300	3.6
H120	Full	30	3600	114,000	14.3	132,500	4.8	128,200	20.0	105,400	3.8	117,300	15.7	84,500	3.3
	Part	20	2400	74,100	15.2	83,600	4.8	87,400	25.2	67,400	3.9	82,600	21.4	58,900	3.4
H150	Full	36	4500	142,100	14.7	137,200	4.2	152,880	19.6	117,600	4.0	147,000	16.3	88,200	3.1
	Part	18	2300	68,600	15.7	65,660	4.5	78,400	20.6	53,900	4.1	73,500	18.6	49,000	3.2
H180	Full	45	5200	171,500	13.2	181,300	4.2	186,200	18.6	148,960	3.7	176,400	15.2	119,560	3.1
	Part	28	2800	85,260	14.2	88,200	4.3	93,100	21.6	69,580	3.9	90,160	18.6	64,680	3.2

5/7/24

Cooling capacities based upon 80.6°F DB, 66.2°F WB entering air temperature

Heating capacities based upon 68°F DB, 59°F WB entering air temperature

All ratings based upon 208V operation

Models 084-120 are rated and certified in accordance with ISO/AHRI/ASHRAE 13256-1

Models 150-360 are rated in accordance with ISO/AHRI/ASHRAE 13256-1 but are not certified since their capacity exceeds the scope of the AHRI program.

# AHRI Data cont

The performance standard AHRI/ASHRAE/ISO 13256-1 became effective January 1, 2000 and replaces AHRI Standards 320, 325, and 330. This new standard has three major categories: Water Loop (comparable to ARI 320), Ground Water (ARI 325), and Ground Loop (ARI 330). Although these standards are similar there are some differences:

**Unit of Measure: The Cooling COP**

The cooling efficiency is measured in EER (US version measured in Btu/h per Watt. The Metric version is measured in a cooling COP (Watt per Watt) similar to the traditional COP measurement.

**Water Conditions Differences**

Entering water temperatures have changed to reflect the centigrade temperature scale. For instance the water loop heating test is performed with 68°F (20°C) water rounded down from the old 70°F (21.1°C).

**Air Conditions Differences**

Entering air temperatures have also changed (rounded down) to reflect the centigrade temperature scale. For instance the cooling tests are performed with 80.6°F (27°C) dry bulb and 66.2°F (19°C) wet bulb entering air instead of the traditional 80°F (26.7°C) DB and 67°F (19.4°C) WB entering air temperatures. 80.6/66.2 data may be converted to 80/67 using the entering air correction table. This represents a significantly lower relative humidity than the old 80/67 of 50% and will result in lower latent capacities.

**Pump Power Correction Calculation**

Within each model, only one water flow rate is specified for all three groups and pumping Watts are calculated using the following formula. This additional power is added onto the existing power consumption.

• Pump power correction = (gpm x 0.0631) x (Press Drop x 2990) / 300

Where 'gpm' is waterflow in gpm and 'Press Drop' is the pressure drop through the unit heat exchanger at rated water flow in feet of head.

**Blower Power Correction Calculation**

Blower power is corrected to zero external static pressure using the following equation. The nominal airflow is rated at a specific external static pressure. This effectively reduces the power consumption of the unit and increases cooling capacity but decreases heating capacity. These Watts are significant enough in most cases to increase EER and COPs fairly dramatically over ARI 320, 325, and 330 ratings.

• Blower Power Correction = (cfm x 0.472) x (esp x 249) / 300

Where 'cfm' is airflow in cfm and 'esp' is the external static pressure at rated airflow in inches of water gauge.

**ISO Capacity and Efficiency Calculations**

The following equations illustrate cooling calculations:

• ISO Cooling Capacity = Cooling Capacity (Btu/h) + (Blower Power Correction (Watts) x 3.412)

• ISO EER Efficiency (W/W) = ISO Cooling Capacity (Btu/h) x 3.412 / [Power Input (Watts) - Blower Power Correction (Watts) + Pump Power Correction (Watt)]

The following equations illustrate heating calculations:

• ISO Heating Capacity = Heating Capacity (Btu/h) - (Blower Power Correction (Watts) x 3.412)

• ISO COP Efficiency (W/W) = ISO Heating Capacity (Btu/h) x 3.412 / [Power Input (Watts) - Blower Power Correction (Watts) + Pump Power Correction (Watt)]

**Comparison of Test Conditions**

	ARI 320	ISO/AHRI 13256-1 WLHP	ARI 325	ISO/AHRI 13256-1 GWHP	ARI 330	ISO/AHRI 13256-1 GLHP
<b>Cooling</b>						
Entering Air - DB/WB °F	80/67	80.6/66.2	80/67	80.6/66.2	80/67	80.6/66.2
Entering Water - °F	85	86	50/70	59	77	77
Fluid Flow Rate	*	**	**	**	**	**
<b>Heating</b>						
Entering Air - DB/WB °F	70	68	70	68	70	68
Entering Water - °F	70	68	50/70	50	32	32
Fluid Flow Rate	*	**	**	**	**	**

Note \*: Flow rate is set by 10°F rise in standard cooling test  
Part load entering water conditions not shown.

Note \*\*: Flow rate is specified by the manufacturer

WLHP = Water Loop Heat Pump; GWHP = Ground Water Heat Pump; GLHP = Ground Loop Heat Pump

**Conversions:**

Airflow (lps) = cfm x 0.472;

Water Flow (lps) = gpm x 0.0631;

esp (Pascals) = esp (in wg) x 249;

Press Drop (Pascals) = Press Drop (ft hd) x 2990



## Electrical Availability

Voltage	Two Stage Compressor		
	084	096	120
208-230/60/3	•	•	•
460/60/3	•	•	•
575/60/3	•	•	•

Voltage	Single Stage Compressor, Two Circuits				
	150	180	240	300	360
208-230/60/3	•	•	•	•	•
460/60/3	•	•	•	•	•
575/60/3	•	•	•	•	•

• - Available

# Physical Data

Model	Dual Capacity Compressor and Fan			Two Compressors and Fan		Two Compressors and Two Fans		
	084	096	120	150	180	240	300	360
Compressor	Scroll (1 each)			Scroll (2 each)		Scroll (2 each)		
Factory Charge R454B, oz [kg] (each circuit), Vertical	112	114	180	96	108	168	192	188
Factory Charge R454B, oz [kg] (each circuit), Horizontal	112	114	180	96	108	N/A	N/A	N/A
<b>Blower Motor &amp; Blower</b>								
Blower Motor - Quantity	1	1	1	1	1	2	2	2
Blower Motor Type/Speeds	Backward Curve VS ECM							
Blower Motor 230V - hp [kW]	4.56 [3.4]	4.8 [3.6]	4.8 [3.6]	4.8 [3.6]	4.8 [3.6]	4.8 [3.6]	4.8 [3.6]	4.8 [3.6]
Blower Motor 460V - hp [kW]	5.5 [4.1]	7.2 [5.4]	7.2 [5.4]	7.2 [5.4]	7.2 [5.4]	7.2 [5.4]	7.2 [5.4]	7.2 [5.4]
Blower Wheel Size (Dia), in. [mm]	15.7 [400]	19.7 [500]	19.7 [500]	19.7 [500]	19.7 [500]	19.7 [500]	19.7 [500]	19.7 [500]
<b>Coax and Water Piping</b>								
Water Connections Size - FPT - in [mm]	1 1/4 [31.75]	1 1/4 [31.75]	2 [50.8]	2 [50.8]	2 [50.8]	2 [50.8]	2 [50.8]	2 [50.8]
Coax & Piping Water Volume - gal [l]	1.47 [5.56]	1.47 [5.56]	2.01 [7.61]	2.38 [9.01]	2.72 [10.29]	3.57 [13.53]	4.83 [18.29]	5.26 [19.92]
<b>Vertical Air Coil &amp; Filters</b>								
Air Coil Dimensions (H x W), in. [mm]	40 x 30 [1016 x 762]	40 x 30 [1016 x 762]	40 x 40 [1016 x 1016]	40 x 38.5 [1016 x 978]	40 x 38.5 [1016 x 978]	48 x 67.5 [1219 x 1715]	48 x 67.5 [1219 x 1715]	48 x 67.5 [1219 x 1715]
Air Coil Total Face Area, ft2 [m2]	8.34 [0.77]	8.34 [0.77]	11.11 [1.03]	10.69 [0.99]	10.69 [0.99]	22.5 [2.09]	22.5 [2.09]	22.5 [2.09]
Air Coil Tube Size, in [mm]	3/8 [9.5]	3/8 [9.5]	3/8 [9.5]	3/8 [9.5]	3/8 [9.5]	3/8 [9.5]	3/8 [9.5]	3/8 [9.5]
Air Coil Number of rows	3	3	4	4	4	3	3	3
Filter Standard - 1" [25mm] Pleated MERV 4 Throwaway, in [mm]	40 x 32 [1016 x 813]	40 x 32 [1016 x 813]	40 x 32 [1016 x 813]	42 x 40 [1067 x 1016]	42 x 40 [1067 x 1016]	6- 24 x 24 [610 x 610]	6- 24 x 24 [610 x 610]	6- 24 x 24 [610 x 610]
Filter Standard - 2" [51mm] Pleated MERV 8 Throwaway, in [mm]	40 x 32 [1016 x 813]	40 x 32 [1016 x 813]	40 x 32 [1016 x 813]	42 x 40 [1067 x 1016]	42 x 40 [1067 x 1016]	6- 24 x 24 [610 x 610]	6- 24 x 24 [610 x 610]	6- 24 x 24 [610 x 610]
Filter Standard - 2" [51mm] Pleated MERV 13 Throwaway, in [mm]	40 x 32 [1016 x 813]	40 x 32 [1016 x 813]	40 x 32 [1016 x 813]	42 x 40 [1067 x 1016]	42 x 40 [1067 x 1016]	6- 24 x 24 [610 x 610]	6- 24 x 24 [610 x 610]	6- 24 x 24 [610 x 610]
Filter Standard - 4" [102mm] Pleated MERV 13 Throwaway, in [mm]	40 x 32 [1016 x 813]	40 x 32 [1016 x 813]	40 x 32 [1016 x 813]	42 x 40 [1067 x 1016]	42 x 40 [1067 x 1016]	6- 24 x 24 [610 x 610]	6- 24 x 24 [610 x 610]	6- 24 x 24 [610 x 610]
<b>Horizontal Air Coil &amp; Filters</b>								
Air Coil Dimensions (H x W), in. [mm]	26 x 48 [660 x 1219]	26 x 48 [660 x 1219]	26 x 48 [660 x 1219]	26 x 64 [660 x 1626]	26 x 64 [660 x 1626]			
Air Coil Total Face Area, ft2 [m2]	8.67 [0.81]	8.67 [0.81]	8.67 [0.81]	11.56 [1.07]	11.56 [1.07]			
Air Coil Tube Size, in [mm]	3/8 [9.5]	3/8 [9.5]	3/8 [9.5]	3/8 [9.5]	3/8 [9.5]			
Air Coil Number of rows	3	3	4	4	4			
Filter Standard - 1" [25mm] Pleated MERV 4 Throwaway, in [mm]	2 - 25 x 25 [635 x 635]	2 - 25 x 25 [635 x 635]	2 - 25 x 25 [635 x 635]	2 - 25 x 25 [635 x 635] 1- 18 x 25 [457 x 635]	2 - 25 x 25 [635 x 635] 1- 18 x 25 [457 x 635]			
Filter Standard - 2" [51mm] Pleated MERV 13 Throwaway, in [mm]	2 - 25 x 25 [635 x 635]	2 - 25 x 25 [635 x 635]	2 - 25 x 25 [635 x 635]	2 - 25 x 25 [635 x 635] 1- 18 x 25 [457 x 635]	2 - 25 x 25 [635 x 635] 1- 18 x 25 [457 x 635]			
Filter Standard - 4" [102mm] Pleated MERV 13 Throwaway, in [mm]	2 - 25 x 25 [635 x 635]	2 - 25 x 25 [635 x 635]	2 - 25 x 25 [635 x 635]	2 - 25 x 25 [635 x 635] 1- 18 x 25 [457 x 635]	2 - 25 x 25 [635 x 635] 1- 18 x 25 [457 x 635]			

# Dimensional Data

## LEFT RETURN SHOWN

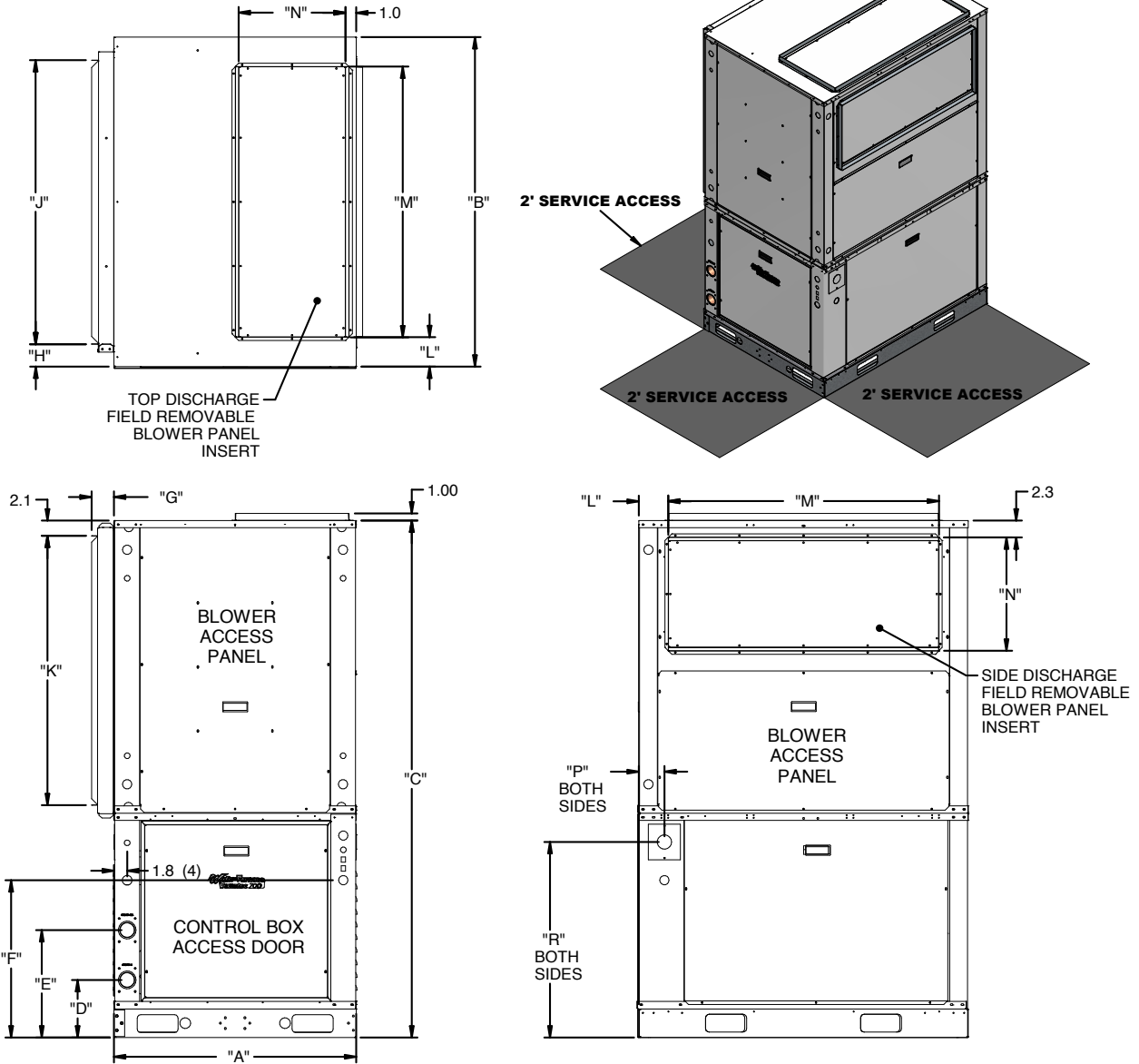

## Vertical Dimensional Data

Vertical Models	Overall Cabinet			Water Connections				Return Connection*				Discharge Connection			Electrical Connections		
	A	B	C	1	2	3		using deluxe filter rack				L	M	N	P	R	
	Width	Depth	Height	In	Out	Condensate	Water FPT	Filter Rack	From Edge	Return Depth	Return Height	From Edge	Supply Width	Supply Height	From Edge	Height	
084-096	in.	34.0	36.3	72.5	8.1	15.1	22.1	1 1/4"	3.1	3.2	29.9	37.8	4.1	28.0	16.0	3.9	27.4
	cm.	86.4	92.2	184.2	20.6	38.4	56.1	31.8 mm	7.9	8.1	75.9	96.0	10.4	71.1	40.6	9.9	69.6
120	in.	34.0	36.3	72.5	8.1	15.1	22.1	2"	3.1	3.2	29.9	37.8	4.1	28.0	16.0	3.9	27.4
	cm.	86.4	92.2	184.2	20.6	38.4	56.1	50.8 mm	7.9	8.1	75.9	96.0	10.4	71.1	40.6	9.9	69.6
150-180	in.	34.0	46.3	72.5	8.1	15.1	22.1	2"	3.1	2.2	39.9	37.8	4.1	38.0	16.0	3.9	27.4
	cm.	86.4	117.5	184.2	20.6	38.4	56.1	50.8 mm	7.9	5.6	101.3	96.0	10.4	96.5	40.6	9.9	69.6

\*Dimensions for return connections are for the deluxe filter rack that is suitable for ducted return applications

**Dimensional Data cont.**

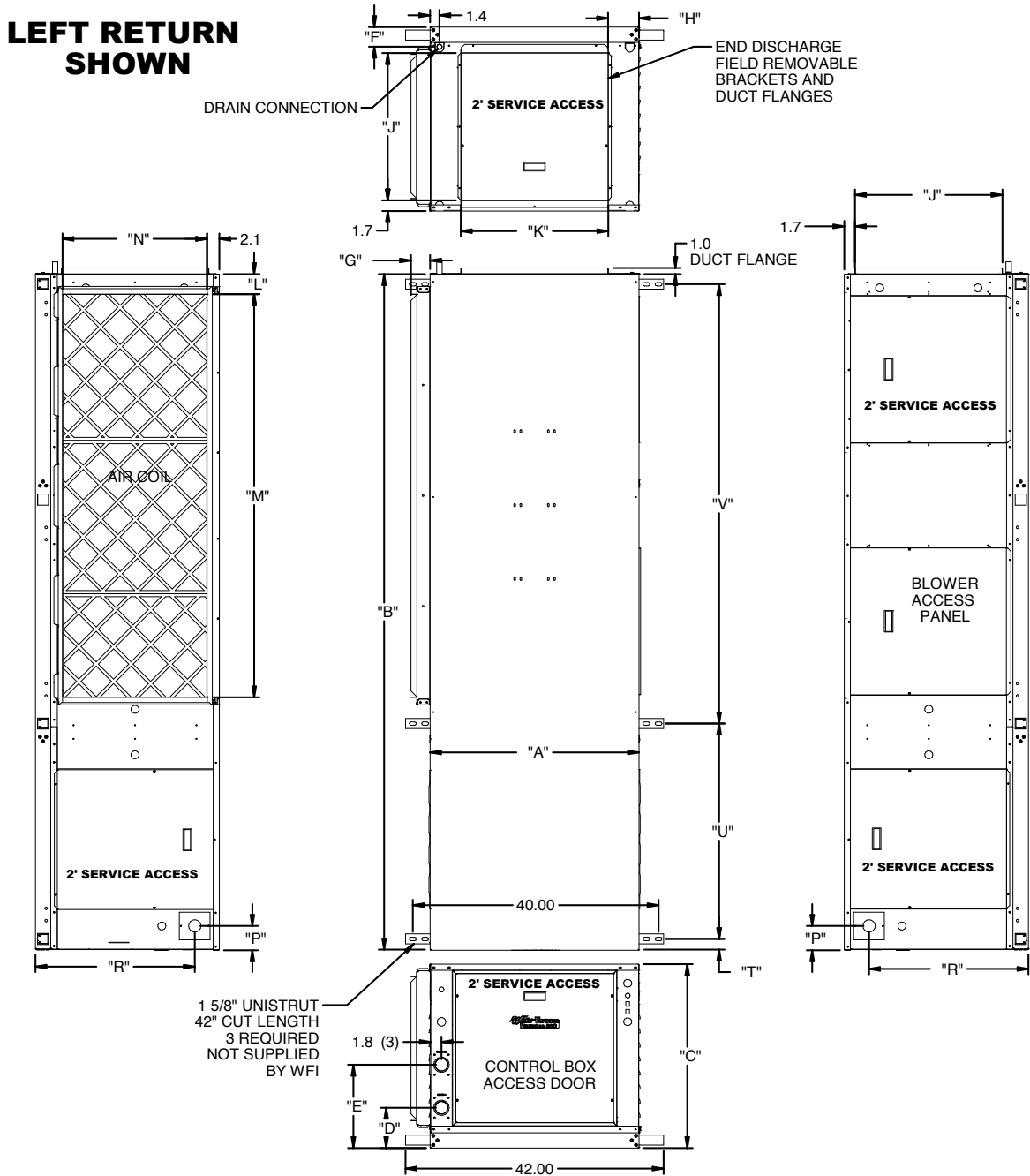

**Horizontal Dimensional Data**

Horizontal Models	Overall Cabinet			Water Connections					Discharge Connection				Return Connection* using deluxe filter rack			Electrical Connections		Unistrut Hanging		
	A	B	C	1	2	5	Loop	G	H	J	K	L	M	N	P	R	T	U	V	
	Width	Depth	Height	In	Out	Condensate	Water FPT	Filter Rack Width	From Edge	Supply Height	Supply Width	From Edge	Return Depth	Return Height	From Edge	Height	From Edge	Unistrut/Unistrut	Unistrut/Unistrut	
084-086	in.	34.0	89.0	29.9	8.1	15.1	3.2	1 1/4"	3.1	5.0	24.0	24.0	4.3	47.6	23.5	3.9	25.9	1.7	24.6	61.0
	cm.	86.4	226.1	75.9	20.6	38.4	8.1	31.8 mm	7.9	12.7	61.0	61.0	10.9	120.9	59.7	9.9	65.8	4.3	62.5	154.9
120	in.	34.0	89.0	29.9	8.1	15.1	3.2	2"	3.1	5.0	24.0	24.0	4.3	47.6	23.5	3.9	25.9	1.7	24.6	61.0
	cm.	86.4	226.1	75.9	20.6	38.4	8.1	50.8 mm	7.9	12.7	61.0	61.0	10.9	120.9	59.7	9.9	65.8	4.3	62.5	154.9
150-180	in.	34.0	110.0	29.9	8.1	15.1	3.2	2"	3.1	5.0	24.0	24.0	4.3	66.6	23.5	3.9	25.9	1.7	35.1	71.5
	cm.	86.4	279.4	75.9	20.6	38.4	8.1	50.8 mm	7.9	12.7	61.0	61.0	10.9	166.6	59.7	9.8	65.8	4.3	89.2	181.6

\*Dimensions for return connections are for the deluxe filter rack that is suitable for ducted return applications

**Dimensional Data cont.**

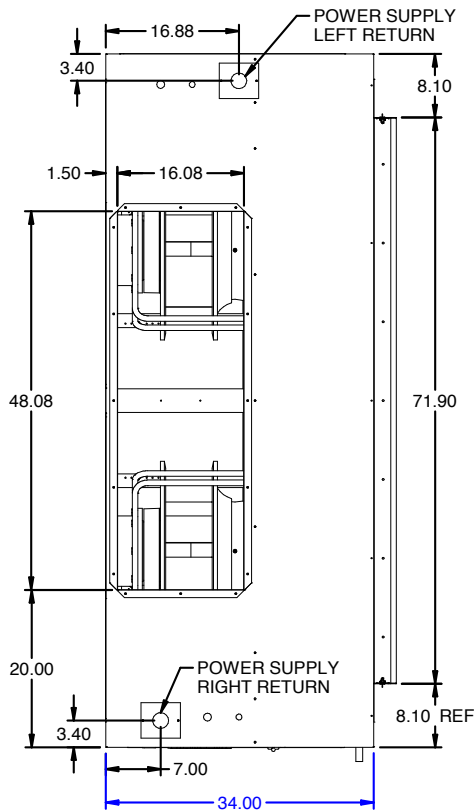

**240-360  
RIGHT RETURN  
SHOWN**

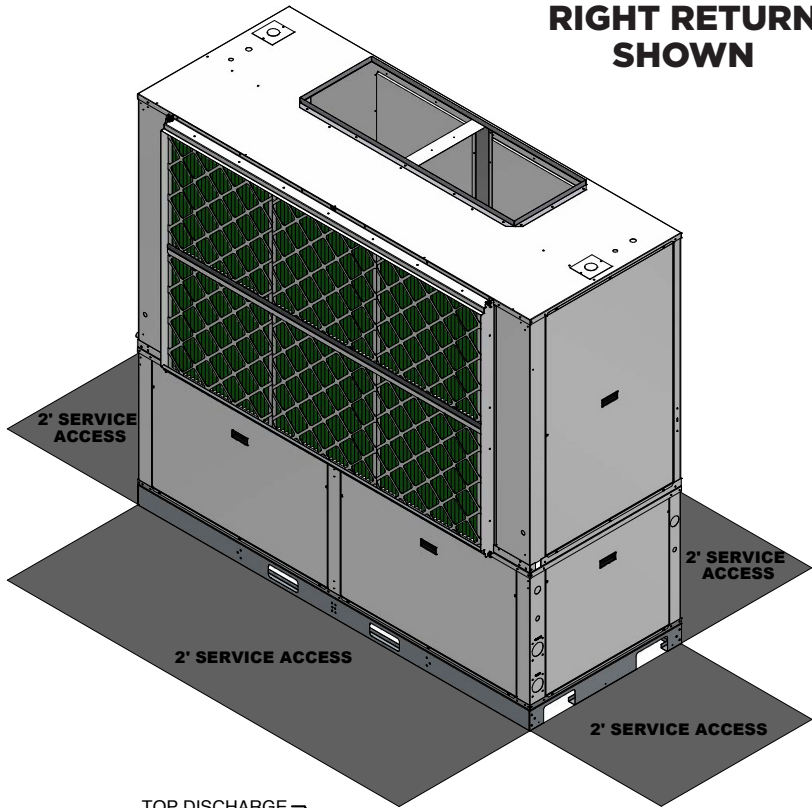

TOP DISCHARGE  
FIELD REMOVABLE  
BLOWER PANEL  
INSERT

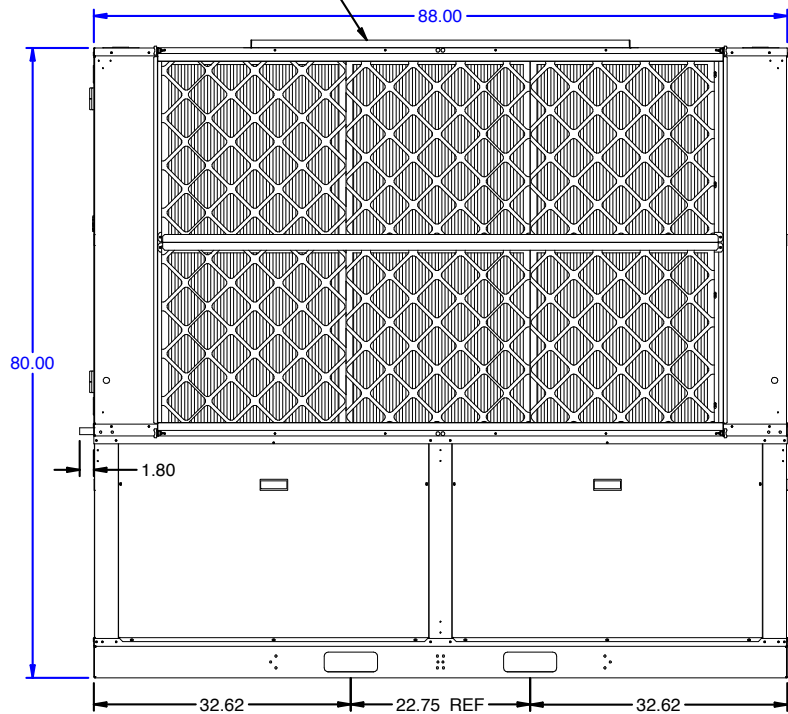
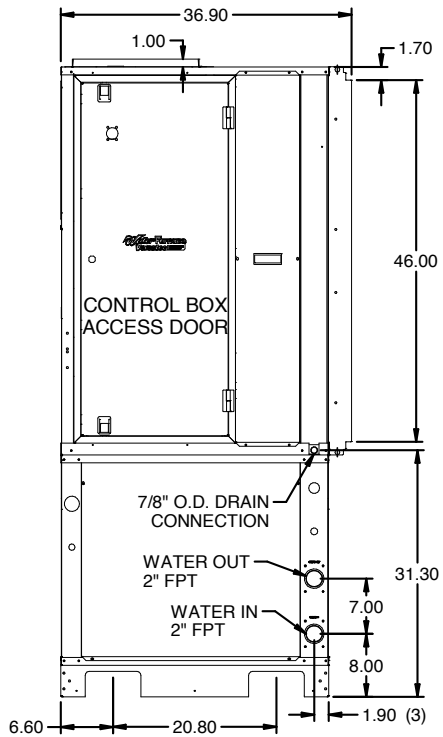

# Dimensional Data cont.

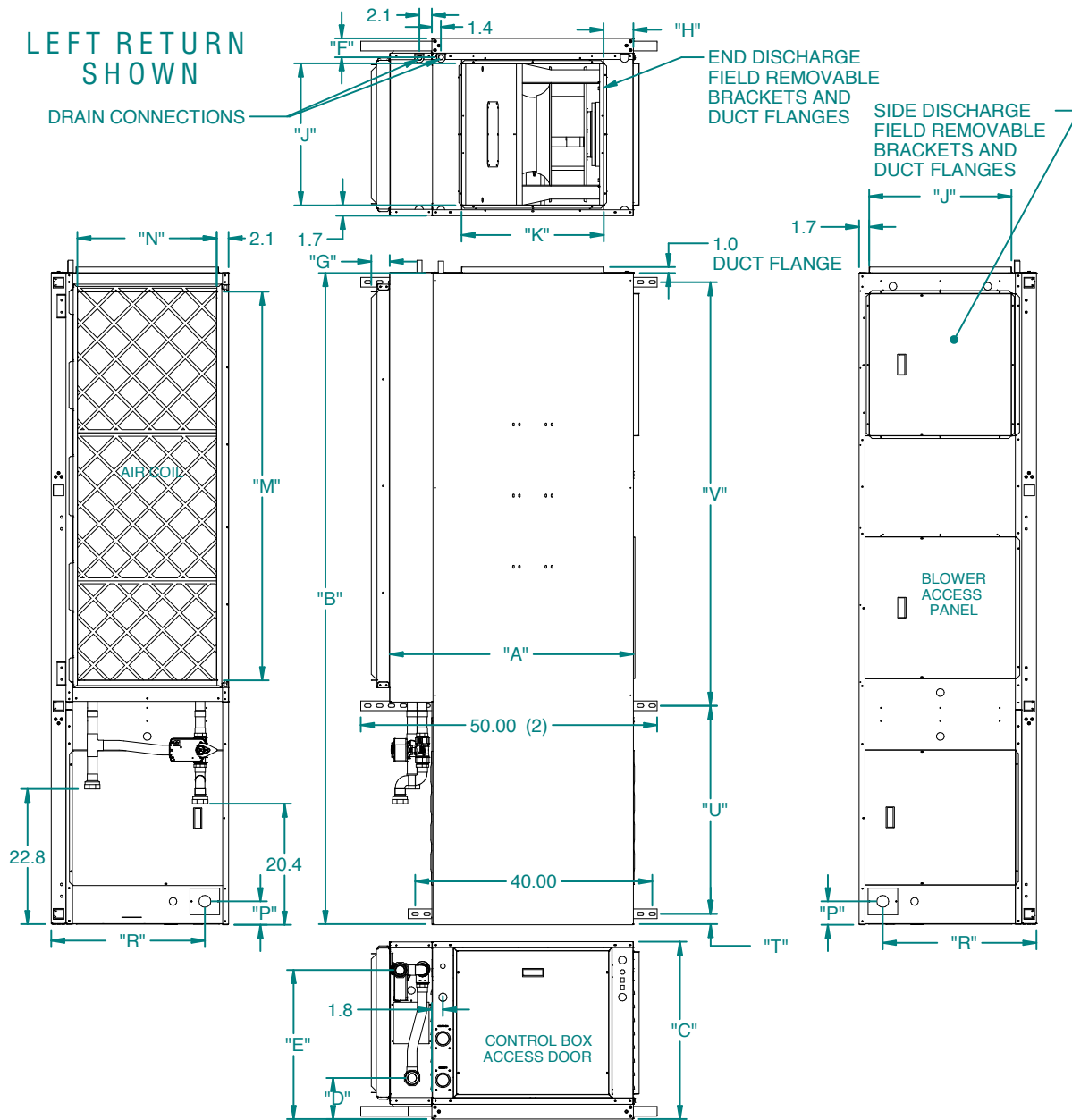

## Horizontal Dimensional Data

Horizontal Models	Overall Cabinet			Water Connections				Discharge Connection				Return Connection*			Electrical Connections		Unistrut Hanging			
	A	B	C	1	2	5	Loop	G	H	J	K	L	M	N	P	R	T	U	V	
	Width	Depth	Height	In	Out	Condensate	Water FPT	Filter Rack Width	From Edge	Supply Height	Supply Width	From Edge	Return Depth	Return Height	From Edge	Height	From Edge	Unistrut/Unistrut	Unistrut/Unistrut	
084-096	in.	41.1	89.0	29.9	6.9	25.1	3.2	1 1/4"	3.1	5.0	24.0	24.0	4.3	47.6	23.5	3.9	25.9	1.7	24.6	61.0
	cm.	104.4	226.1	75.9	17.5	63.8	8.1	31.8 mm	7.9	12.7	61.0	61.0	10.9	120.9	59.7	9.9	65.8	4.3	62.5	154.9
120	in.	41.1	89.0	29.9	6.9	25.1	3.2	2"	3.1	5.0	24.0	24.0	4.3	47.6	23.5	3.9	25.9	1.7	24.6	61.0
	cm.	104.4	226.1	75.9	17.5	63.8	8.1	50.8 mm	7.9	12.7	61.0	61.0	10.9	120.9	59.7	9.9	65.8	4.3	62.5	154.9
150-180	in.	41.1	110.0	29.9	6.9	25.1	3.2	2"	3.1	5.0	24.0	24.0	4.3	65.6	23.5	3.9	25.9	1.7	35.1	71.5
	cm.	104.4	279.4	75.9	17.5	63.8	8.1	50.8 mm	7.9	12.7	61.0	61.0	10.9	166.6	59.7	9.8	65.8	4.3	89.2	181.6

\*Dimensions for return connections are for the deluxe filter rack that is suitable for ducted return applications

**Dimensional Data cont.**

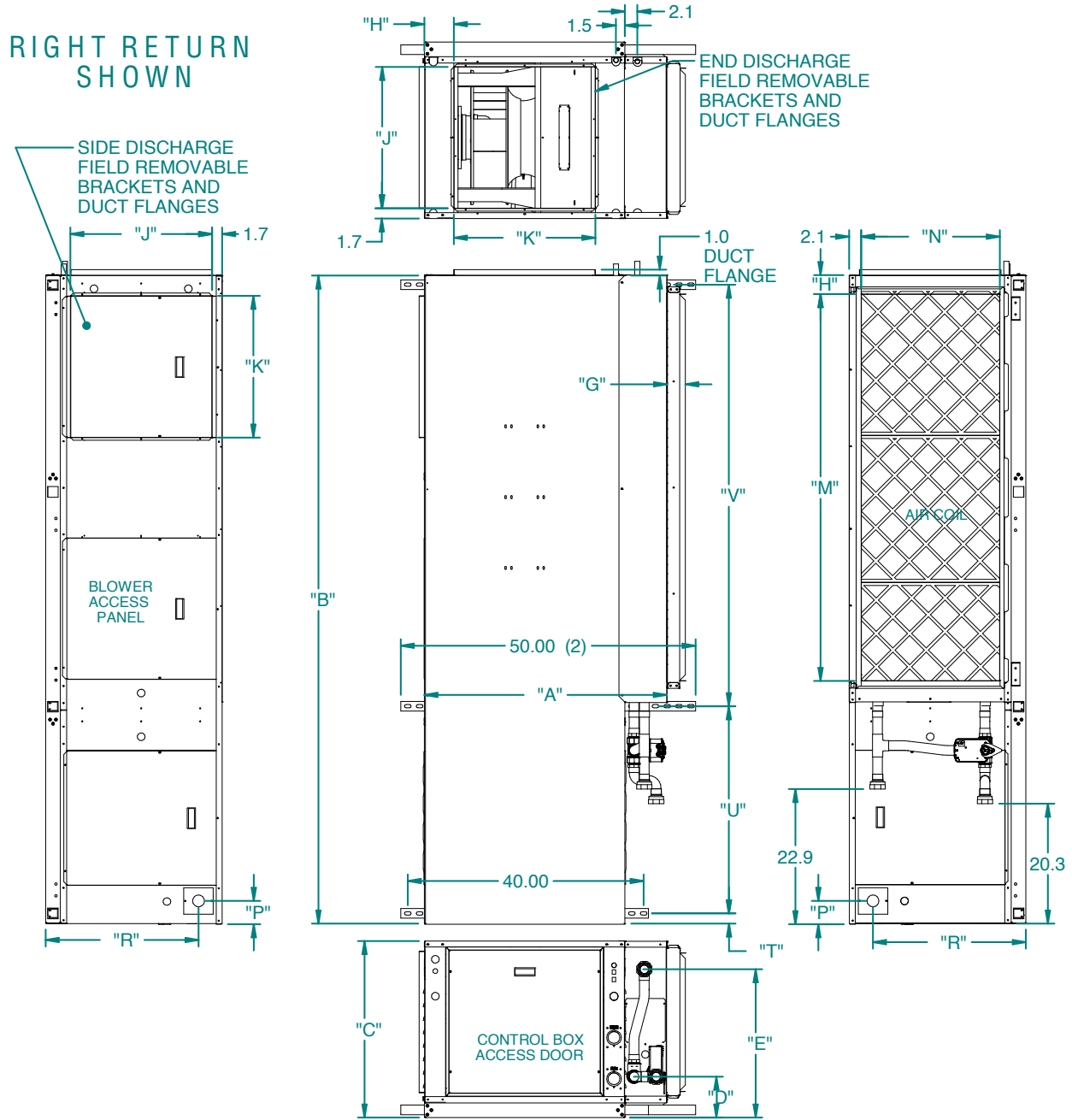

**Horizontal Dimensional Data**

Horizontal Models	Overall Cabinet			Water Connections					Discharge Connection				Return Connection*			Electrical Connections		Unistrut Hanging		
	A	B	C	D	E	F	Loop	G	H	J	K	L	M	N	P	R	T	U	V	
	Width	Depth	Height	In	Out	Condensate	Water FPT	Filter Rack Width	From Edge	Supply Height	Supply Width	From Edge	Return Depth	Return Height	From Edge	Height	From Edge	Unistrut/Unistrut	Unistrut/Unistrut	
084-096	in.	41.1	89.0	29.9	6.9	25.1	3.2	1 1/4"	3.1	5.0	24.0	24.0	4.3	47.6	23.5	3.9	25.9	1.7	24.6	61.0
	cm.	104.4	226.1	75.9	17.5	63.8	8.1	31.8 mm	7.9	12.7	61.0	61.0	10.9	120.9	59.7	9.9	65.8	4.3	62.5	154.9
120	in.	41.1	89.0	29.9	6.9	25.1	3.2	2"	3.1	5.0	24.0	24.0	4.3	47.6	23.5	3.9	25.9	1.7	24.6	61.0
	cm.	104.4	226.1	75.9	17.5	63.8	8.1	50.8 mm	7.9	12.7	61.0	61.0	10.9	120.9	59.7	9.9	65.8	4.3	62.5	154.9
150-180	in.	41.1	110.0	29.9	6.9	25.1	3.2	2"	3.1	5.0	24.0	24.0	4.3	65.6	23.5	3.9	25.9	1.7	35.1	71.5
	cm.	104.4	279.4	75.9	17.5	63.8	8.1	50.8 mm	7.9	12.7	61.0	61.0	10.9	166.6	59.7	9.8	65.8	4.3	89.2	181.6

\*Dimensions for return connections are for the deluxe filter rack that is suitable for ducted return applications

**Dimensional Data cont.**

**084-180 TOP FLOW ECONOMIZER OPTION LR**

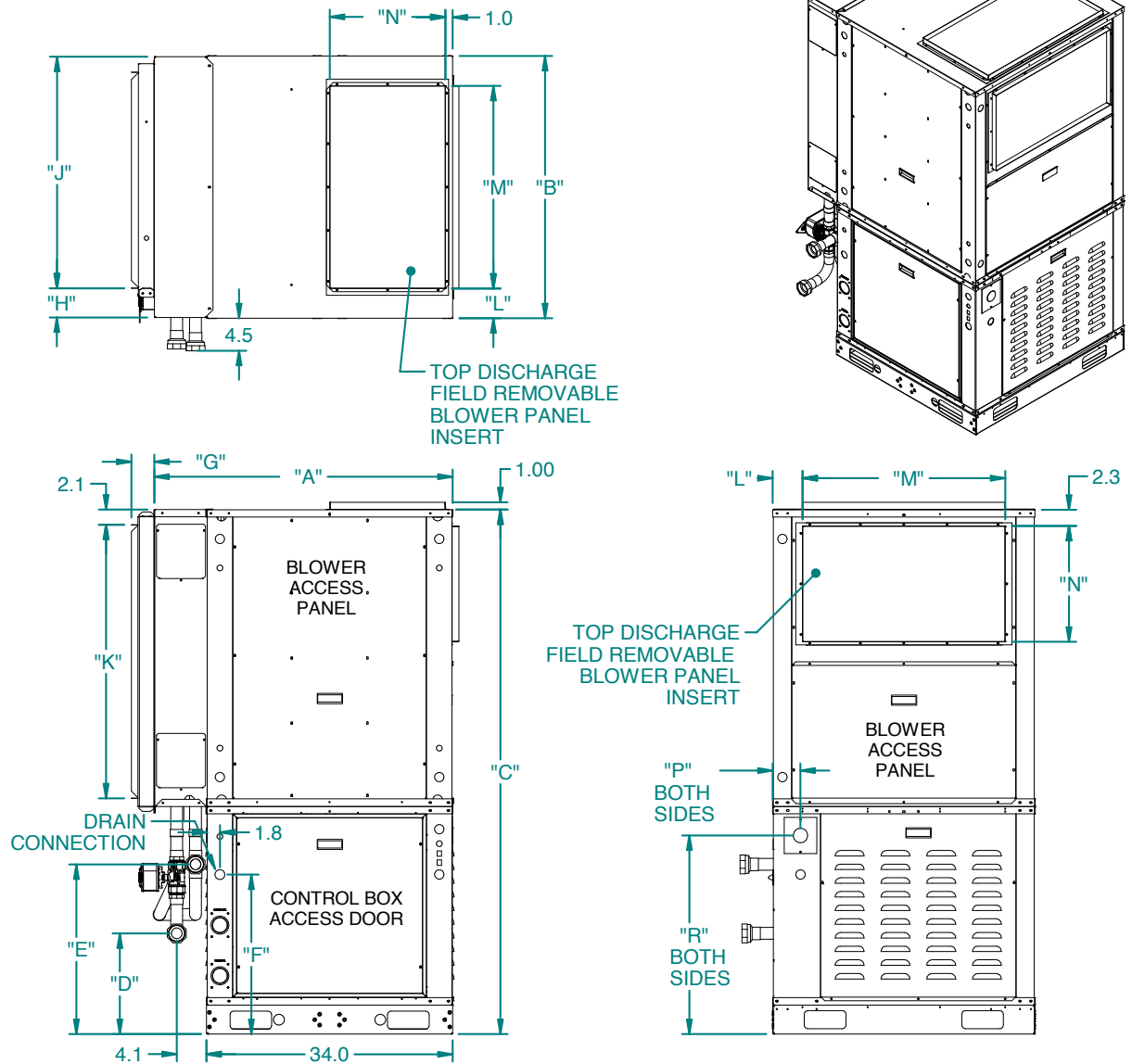

**Vertical Dimensional Data**

Vertical Models	Overall Cabinet			Water Connections				Return Connection*				Discharge Connection			Electrical Connections		
	A	B	C	1	2	3		using deluxe filter rack				L	M	N	P	R	
	Width	Depth	Height	In	Out	Condensate	Water FPT	Filter Rack	From Edge	Return Depth	Return Height	From Edge	Supply Width	Supply Height	From Edge	Height	
084-096	in.	41.2	36.3	72.5	13.9	23.5	22.1	1 1/4"	3.1	3.2	29.9	37.8	4.1	28.0	16.0	3.9	27.4
	cm.	104.6	92.2	184.2	35.3	59.7	56.1	31.8 mm	7.9	8.1	75.9	96.0	10.4	71.1	40.6	9.9	69.6
120	in.	41.2	36.3	72.5	13.9	23.5	22.1	2"	3.1	3.2	29.9	37.8	4.1	28.0	16.0	3.9	27.4
	cm.	104.6	92.2	184.2	35.3	59.7	56.1	50.8 mm	7.9	8.1	75.9	96.0	10.4	71.1	40.6	9.9	69.6
150-180	in.	41.2	46.3	72.5	14.7	24.2	22.1	2"	3.1	2.2	39.9	37.8	4.1	38.0	16.0	3.9	27.4
	cm.	104.6	117.5	184.2	37.3	61.5	56.1	50.8 mm	7.9	5.6	101.3	96.0	10.4	96.5	40.6	9.9	69.6



**Dimensional Data cont.**

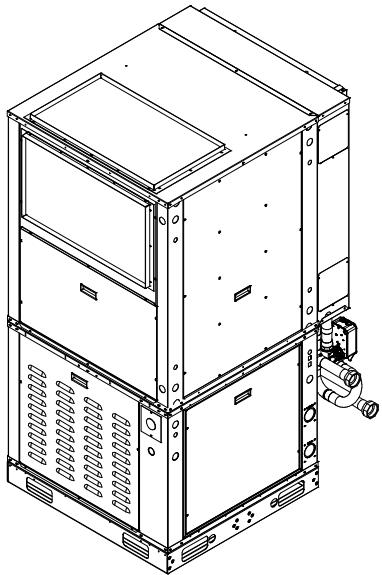

**084-180 TOP FLOW ECONOMIZER OPTION RR**

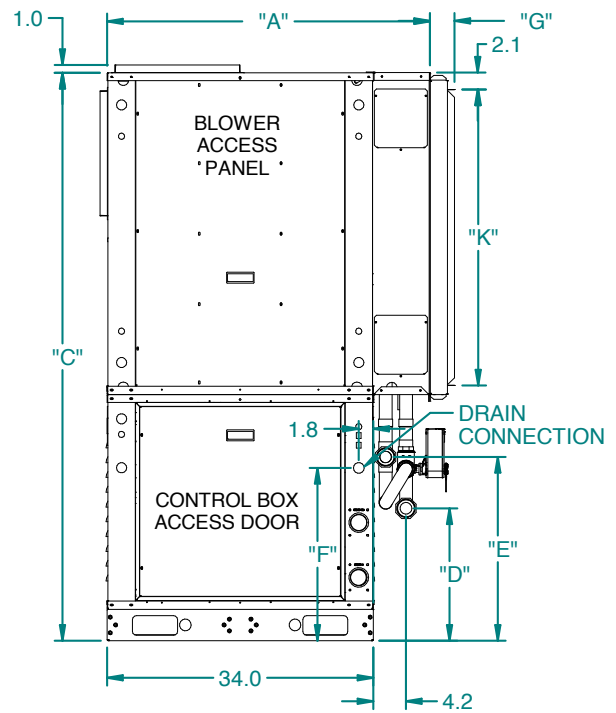
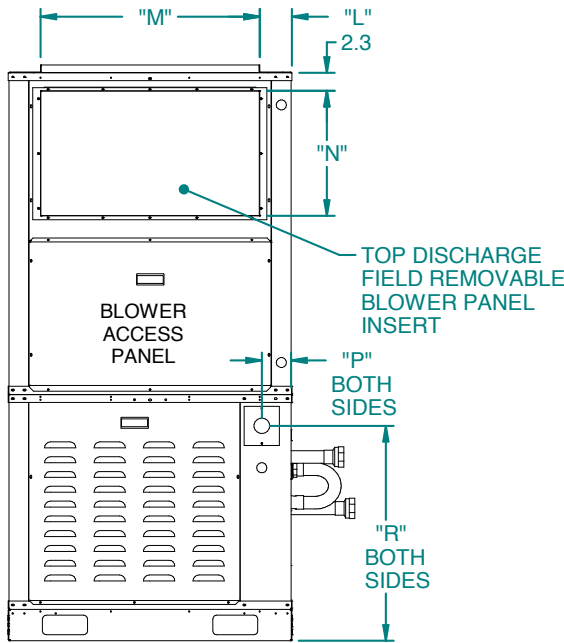
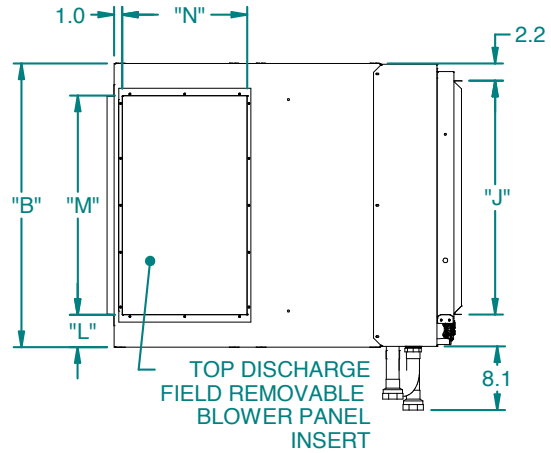

**Vertical Dimensional Data**

Vertical Models	Overall Cabinet			Water Connections				Return Connection*				Discharge Connection			Electrical Connections		
	A	B	C	1	2	3	using deluxe filter rack				L	M	N	P	R		
	Width	Depth	Height	In	Out	Condensate	Water FPT	Filter Rack	From Edge	Return Depth	Return Height	From Edge	Supply Width	Supply Height	From Edge	Height	
084-096	in.	41.2	36.3	72.5	16.9	23.5	22.1	1 1/4"	3.1	3.2	29.9	37.8	4.1	28.0	16.0	3.9	27.4
	cm.	104.6	92.2	184.2	42.9	59.7	56.1	31.8 mm	7.9	8.1	75.9	96.0	10.4	71.1	40.6	9.9	69.6
120	in.	41.2	36.3	72.5	16.9	23.5	22.1	2"	3.1	3.2	29.9	37.8	4.1	28.0	16.0	3.9	27.4
	cm.	104.6	92.2	184.2	42.9	59.7	56.1	50.8 mm	7.9	8.1	75.9	96.0	10.4	71.1	40.6	9.9	69.6
150-180	in.	41.2	46.3	72.5	17.7	24.2	22.1	2"	3.1	2.2	39.9	37.8	4.1	38.0	16.0	3.9	27.4
	cm.	104.6	117.5	184.2	45.0	61.5	56.1	50.8 mm	7.9	5.6	101.3	96.0	10.4	96.5	40.6	9.9	69.6

**Dimensional Data cont.**

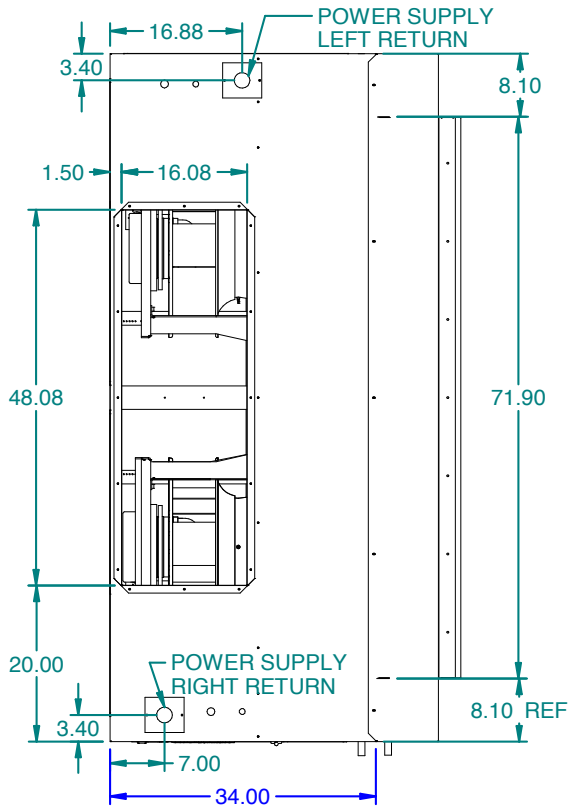

240-360  
RIGHT RETURN  
SHOWN

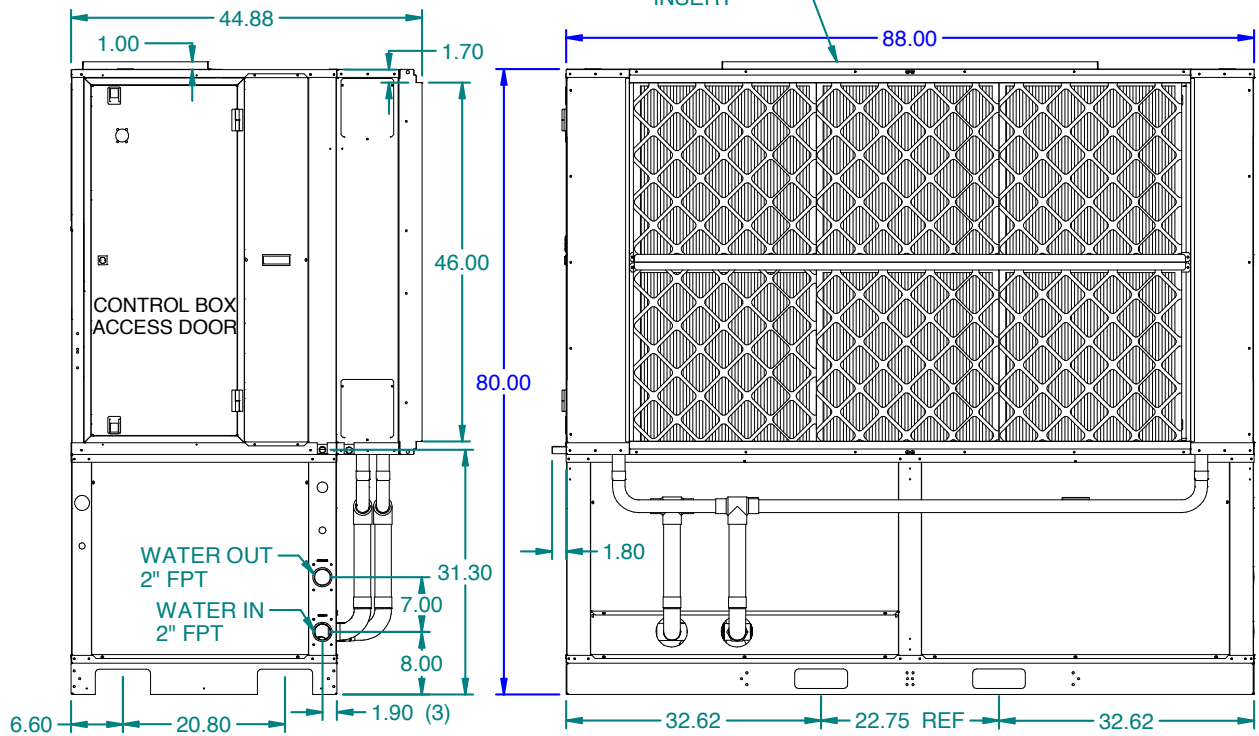
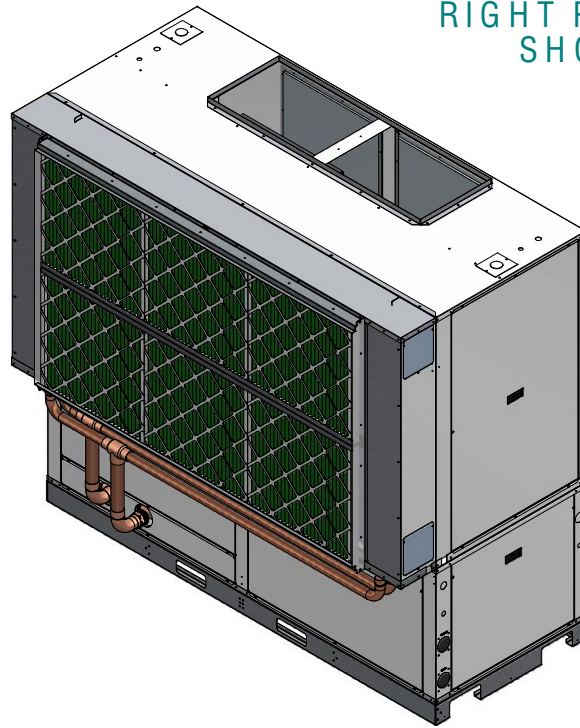

## Electrical Data

### WARNING

During repairs to sealed components, all electrical supplies shall be disconnected from the equipment being worked upon prior to any removal of sealed covers, etc. If it is absolutely necessary to have an electrical supply to equipment during servicing, then a permanently operating form of leak detection shall be located at the most critical point to warn of a potentially hazardous situation.

Sealed electrical components shall be replaced.

### WARNING

Do not apply any permanent inductive or capacitance loads to the circuit with out ensuring that this will not exceed the permissible voltage and current permitted for the equipment in use.

Intrinsically safe components must be replaced.

Replace components only with parts specified by the manufacturer. Other parts may result in the ignition of refrigerant in the atmosphere from a leak.

**NOTE** The use of silicon sealant can inhibit the effectiveness of some types of leak detection equipment. Intrinsically safe components do not have to be isolated prior to working on them.

## Electrical Data

Model	Rated Voltage	Voltage Min/ Max	Compressor (each)			Blower Motor (each) FLA	Total Unit FLA	Min Circ Amp	Max Fuse/ HACR Breaker	
			MCC	RLA	LRA					
Dual Capacity Compressor	084	208-230/60/3	187/253	39.5	25.1	200.0	5.3	30.4	36.7	60
		460/60/3	414/506	16.5	10.6	79.1	3.0	13.6	16.3	25
		575/60/3	518/632	13.4	8.6	65.0	2.4	11.0	13.2	20
	096	208-230/60/3	187/253	38.5	24.7	178.5	7.0	31.7	37.9	60
		460/60/3	414/506	16.8	10.8	95.3	4.0	14.8	17.5	25
		575/60/3	518/632	14.3	9.2	65.0	3.2	12.4	14.7	20
	120	208-230/60/3	187/253	41.4	26.5	255.0	7.0	33.5	40.1	65
		460/60/3	414/506	21.6	13.8	123.0	4.0	17.8	21.3	35
		575/60/3	518/632	17.9	11.5	93.7	3.2	14.7	17.6	25
Two Compressors & Plenum Fan	150	208-230/60/3	187/253	33.0	21.2	156.5	9.2	51.6	56.9	75
		460/60/3	414/506	14.2	9.1	74.8	6.8	25.0	27.3	35
		575/60/3	518/632	12.0	7.7	47.8	5.4	20.8	22.8	30
	180	208-230/60/3	187/253	38.1	24.4	200.0	9.2	58.0	64.1	85
		460/60/3	414/506	18.5	11.9	103.0	6.8	30.6	33.6	45
		575/60/3	518/632	14.6	9.4	78.0	5.4	24.2	26.6	35
Two Compressors & Two Plenum Fans	240	208-230/60/3	187/253	44.5	28.5	255.0	9.2	75.4	82.5	110
		460/60/3	414/506	21.0	13.5	123.0	6.8	40.6	44.0	55
		575/60/3	518/632	16.7	10.7	93.7	5.4	32.3	35.0	45
	300	208-230/60/3	187/253	63.6	40.8	270.0	9.2	100.0	110.2	150
		460/60/3	414/506	30.3	19.4	147.0	6.8	52.4	57.3	75
		575/60/3	518/632	21.4	13.7	109.0	5.4	38.3	41.7	55
	360	208-230/60/3	187/253	75.0	48.1	351.0	9.2	114.6	126.6	175
		460/60/3	414/506	38.6	24.7	197.0	6.8	63.0	69.2	90
		575/60/3	518/632	35.0	22.4	135.0	5.4	55.7	61.3	80

## Fuse Replacement

Model Size	Line Voltage/ Frequency/ Phase	Disconnect Fuse (if applicable)		Branch Circuit Fuse		Blower Power Fuse		Compressor Power Fuse		Transformer Primary Fuse	
		Size (A)	Type	Size (A)	Type	Size (A)	Type	Size (A)	Type	Size (A)	Type
084	208-230/60/3	60	Class J	60	Class J	10	Cube*	50	Cube*	0.75	Class CC
	460/60/3	30	Class J	25	Class J	6	Cube*	20	Cube*	0.75	Class CC
	575/60/3	30	Class J	20	Class J	6	Cube*	15	Cube*	0.75	Class CC
096	208-230/60/3	60	Class J	60	Class J	15	Cube*	50	Cube*	0.75	Class CC
	460/60/3	30	Class J	25	Class J	10	Cube*	20	Cube*	0.75	Class CC
	575/60/3	30	Class J	20	Class J	6	Cube*	20	Cube*	0.75	Class CC
120	208-230/60/3	100	Class J	60	Class J	15	Cube*	50	Cube*	0.75	Class CC
	460/60/3	60	Class J	35	Class J	10	Cube*	30	Cube*	0.75	Class CC
	575/60/3	30	Class J	25	Class J	6	Cube*	25	Cube*	0.75	Class CC
150	208-230/60/3	100	Class J	70	Class J	20	Cube*	40	Cube*	0.75	Class CC
	460/60/3	60	Class J	35	Class J	15	Cube*	20	Cube*	0.75	Class CC
	575/60/3	30	Class J	30	Class J	10	Cube*	15	Cube*	0.75	Class CC
180	208-230/60/3	100	Class J	80	Class J	20	Cube*	50	Cube*	0.75	Class CC
	460/60/3	60	Class J	45	Class J	15	Cube*	25	Cube*	0.75	Class CC
	575/60/3	60	Class J	35	Class J	10	Cube*	20	Cube*	0.75	Class CC
240	208-230/60/3	200	Class J	110	Class J	20	Cube*	60	Cube*	0.75	Class CC
	460/60/3	60	Class J	50	Class J	15	Cube*	30	Cube*	0.75	Class CC
	575/60/3	60	Class J	45	Class J	10	Cube*	20	Cube*	0.75	Class CC
300	208-230/60/3	200	Class J	150	Class J	20	Cube*	90	Cube*	0.75	Class CC
	460/60/3	100	Class J	70	Class J	15	Cube*	40	Cube*	0.75	Class CC
	575/60/3	60	Class J	50	Class J	10	Cube*	30	Cube*	0.75	Class CC
360	208-230/60/3	200	Class J	175	Class J	20	Cube*	100	Cube*	0.75	Class CC
	460/60/3	100	Class J	90	Class J	15	Cube*	50	Cube*	0.75	Class CC
	575/60/3	100	Class J	80	Class J	10	Cube*	50	Cube*	0.75	Class CC

\* Meets Class J requirements

## Unit Weight

Model	Vertical Shipping Weight	Horizontal Shipping Weight
084	700	756
	(318)	(343)
096	700	756
	(318)	(343)
120	740	931
	(336)	(422)
150	1,060	1,101
	(481)	(499)
180	1,066	1,107
	(484)	(502)
240	1,816	
	(824)	
300	1,892	
	(858)	
360	1,970	
	(894)	

Weights are listed in lbs. (kg).

2/8/2023

# Blower Performance Data

## Integrated EC Backward Curved Plenum Fan Performance

### Model 084

Fan Speed	Fan RPM	Airflow [cfm] at External Static Pressure [in. wg.]																				
		0.0	0.1	0.2	0.3	0.4	0.5	0.6	0.7	0.8	0.9	1.0	1.1	1.2	1.3	1.4	1.5	1.6	1.7	1.8	1.9	2.0
1	900	1395	1315	1215	1090	940	775	495														
2	1100	1725	1640	1570	1485	1400	1280	1150	1015	870	620											
3	1300	2055	1985	1925	1865	1800	1725	1645	1550	1435	1315	1190	1060	1055	870							
4	1400	2220	2165	2100	2045	1990	1915	1850	1770	1685	1595	1490	1375	1260	1105	955						
5	1600	2555	2505	2435	2390	2335	2285	2230	2175	2110	2045	1970	1885	1800	1705	1605	1510	1375	1265			
6	1700	2715	2660	2610	2545	2505	2460	2415	2365	2305	2250	2180	2125	2050	1970	1885	1800	1695	1600	1495	1350	1275
7	1800	2810	2785	2705	2655	2600	2540	2495	2415	2355	2305	2265	2210	2175	2120	2085	2015	1965	1905	1855	1795	1705
8	1900	2970	2910	2865	2805	2775	2715	2665	2615	2575	2520	2460	2405	2360	2300	2245	2185	2130	2075	2020	1965	1895
9	2000	3145	3105	3075	3015	2945	2900	2855	2805	2745	2695	2655	2585	2520	2475	2430	2380	2305	2245	2175	2100	2030
10	2100	3320	3300	3285	3225	3115	3085	3045	2995	2915	2870	2850	2765	2680	2650	2615	2575	2480	2415	2330	2235	2165
11	2200	3460	3415	3380	3315	3245	3240	3195	3120	3085	3050	3020	2985	2915	2865	2805	2780	2715	2635	2575	2520	2475
12	2300	3625	3575	3505	3460	3425	3395	3345	3245	3255	3230	3190	3165	3120	3075	3025	2990	2950	2855	2820	2785	2715

Fan selection is accomplished through the Aurora Controls and allows four online selections of continuous fan (G), L = stage 1 (Y1), H = stage 2 (Y2), and Aux = electric heat. 3/30/21

Continuous Fan (G) can be set at any airflow. Factory setting is 1.

L = Stage 1 (Y1) factory setting is 3.

H = Stage 2 (Y2) factory setting is 8.

Electric Heat Operation (AUX) = Stage 3 factory setting is 10.

Elect heat Airflow (AUX) airflow setting should be configured for the minimum airflow needed to support the heater. Please consult heater manual.

### Model 096

Fan Speed	Fan RPM	Airflow [cfm] at External Static Pressure [in. wg.]																				
		0.0	0.1	0.2	0.3	0.4	0.5	0.6	0.7	0.8	0.9	1.0	1.1	1.2	1.3	1.4	1.5	1.6	1.7	1.8	1.9	2.0
1	600	1530	1430	1205	915	525	420															
2	700	1835	1710	1530	1410	1165	870	495														
3	800	2145	2030	1895	1740	1565	1385	1125	825	570												
4	900	2530	2415	2290	2145	1985	1825	1665	1440	1200	920											
5	1000	2815	2720	2620	2505	2365	2235	2085	1915	1755	1555	1325	1115	780								
6	1100	3135	3045	2955	2830	2735	2615	2470	2335	2195	2045	1915	1745	1490	1315							
7	1200	3440	3360	3275	3195	3095	2985	2895	2750	2645	2505	2375	2225	2085	1915	1730	1525	1235				
8	1300	3745	3685	3595	3505	3415	3335	3235	3120	3035	2910	2795	2680	2555	2420	2305	2150	1955	1770	1575		
9	1400	4045	3995	3905	3830	3775	3680	3580	3500	3415	3310	3195	3165	2985	2875	2750	2630	2505	2375	2255	2070	1905
10	1500	4370	4285	4220	4150	4085	4010	3920	3850	3775	3680	3595	3505	3400	3305	3195	3075	2940	2830	2750	2645	2525
11	1600	4875	4575	4545	4480	4400	4335	4250	4200	4115	4065	3975	3865	3795	3695	3600	3500	3395	3290	3180	3085	2970
12	1700	5200	5120	5060	5000	4935	4665	4575	4510	4415	4345	4280	4210	4130	4040	3960	3875	3795	3680	3605	3515	3425

Fan selection is accomplished through the Aurora Controls and allows four online selections of continuous fan (G), L = stage 1 (Y1), H = stage 2 (Y2), and Aux = electric heat. 3/30/21

Continuous Fan (G) can be set at any airflow. Factory setting is 1.

L = Stage 1 (Y1) factory setting is 4.

H = Stage 2 (Y2) factory setting is 7.

Electric Heat Operation (AUX) = Stage 3 factory setting is 10.

Elect heat Airflow (AUX) airflow setting should be configured for the minimum airflow needed to support the heater. Please consult heater manual.

### Model 120

Fan Speed	Fan RPM	Airflow [cfm] at External Static Pressure [in. wg.]																				
		0.0	0.1	0.2	0.3	0.4	0.5	0.6	0.7	0.8	0.9	1.0	1.1	1.2	1.3	1.4	1.5	1.6	1.7	1.8	1.9	2.0
1	700	1835	1710	1530	1410	1165	870	495														
2	800	2145	2030	1895	1740	1565	1385	1125	825	570												
3	900	2530	2415	2290	2145	1985	1825	1665	1440	1200	920											
4	1000	2815	2720	2620	2505	2365	2235	2085	1915	1755	1555	1325	1115	780								
5	1100	3135	3045	2955	2830	2735	2615	2470	2335	2195	2045	1915	1745	1490	1315							
6	1200	3440	3360	3275	3195	3095	2985	2895	2750	2645	2505	2375	2225	2085	1915	1730	1525	1235				
7	1300	3745	3685	3595	3505	3415	3335	3235	3120	3035	2910	2795	2680	2555	2420	2305	2150	1955	1770	1575		
8	1400	4045	3995	3905	3830	3775	3680	3580	3500	3415	3310	3195	3165	2985	2875	2750	2630	2505	2375	2255	2070	1905
9	1500	4370	4285	4220	4150	4085	4010	3920	3850	3775	3680	3595	3505	3400	3305	3195	3075	2940	2830	2750	2645	2525
10	1600	4875	4775	4545	4480	4400	4335	4250	4200	4115	4065	3975	3865	3795	3695	3600	3500	3395	3290	3180	3085	2970
11	1700	5200	5120	5060	5000	4935	4665	4575	4510	4415	4345	4280	4210	4130	4040	3960	3875	3795	3680	3605	3515	3425
12	1800	5525	5405	5310	5200	5105	4995	4860	4755	4695	4625	4555	4480	4410	4350	4295	4225	4160	4070	3985	3900	3820

Fan selection is accomplished through the Aurora Controls and allows four online selections of continuous fan (G), L = stage 1 (Y1), H = stage 2 (Y2), and Aux = electric heat. 3/30/21

Continuous Fan (G) can be set at any airflow. Factory setting is 1.

L = Stage 1 (Y1) factory setting is 4.

H = Stage 2 (Y2) factory setting is 8.

Electric Heat Operation (AUX) = Stage 3 factory setting is 10.

Elect heat Airflow (AUX) airflow setting should be configured for the minimum airflow needed to support the heater. Please consult heater manual.

# Blower Performance Data cont.

## Model 150

Fan Speed	Fan RPM	Airflow [cfm] at External Static Pressure [in. wg.]																				
		0.0	0.1	0.2	0.3	0.4	0.5	0.6	0.7	0.8	0.9	1.0	1.1	1.2	1.3	1.4	1.5	1.6	1.7	1.8	1.9	2.0
1	900	2780	2665	2545	2400	2230	2055	1880	1650													
2	1000	3095	2990	2885	2780	2675	2515	2345	2175	2005	1830	1590										
3	1100	3415	3325	3230	3135	3045	2905	2795	2680	2570	2460	2155	1985									
4	1200	3750	3660	3565	3470	3370	3275	3165	3055	2935	2805	2680	2530	2375	2195	1995						
5	1300	4055	3980	3905	3815	3725	3635	3540	3445	3335	3215	3100	2975	2845	2700	2545	2385	2190	1995	1802		
6	1400	4375	4305	4230	4155	4070	3985	3900	3815	3720	3620	3520	3395	3275	3160	3040	2925	2765	2605	2445	2285	2120
7	1500	4810	4700	4585	4495	4420	4345	4255	4170	4090	4015	3945	3840	3735	3635	3530	3425	3295	3165	3035	2895	2765
8	1600	5245	5095	4940	4835	4770	4685	4605	4525	4450	4385	4320	4225	4135	4035	3945	3855	3745	3640	3530	3415	3300
9	1700	5680	5490	5295	5175	5120	5025	4955	4880	4810	4755	4680	4600	4520	4435	4345	4255	4175	4090	4000	3895	3795
10	1800	6115	5885	5650	5515	5470	5365	5305	5235	5170	5125	5040	4975	4905	4835	4730	4650	4570	4490	4405	4315	4220
11	1900	6550	6280	6005	5855	5820	5705	5655	5590	5530	5495	5400	5350	5290	5235	5115	5045	4965	4890	4810	4735	4645
12	2000	6985	6675	6360	6195	6155	6045	6005	5945	5890	5865	5760	5725	5675	5635	5500	5440	5360	5290	5215	5155	5070

Fan selection is accomplished through the Aurora Controls and allows four online selections of continuous fan (G), L = stage 1 (Y1), 3/30/21

H = stage 2 (Y2), and Aux = electric heat.

Continuous Fan (G) can be set at any airflow. Factory setting is 1.

L = Stage 1 (Y1) factory setting is 2.

H = Stage 2 (Y2) factory setting is 9.

Electric Heat Operation (AUX) = Stage 3 factory setting is 10.

Elect heat Airflow (AUX) airflow setting should be configured for the minimum airflow needed to support the heater. Please consult heater manual.

## Model 180

Fan Speed	Fan RPM	Airflow [cfm] at External Static Pressure [in. wg.]																				
		0.0	0.1	0.2	0.3	0.4	0.5	0.6	0.7	0.8	0.9	1.0	1.1	1.2	1.3	1.4	1.5	1.6	1.7	1.8	1.9	2.0
1	900	2454	2341	2214	2075	1923	1758	1580	1389													
2	1000	2978	2881	2773	2669	2531	2407	2253	2087	1908	1679	1432										
3	1100	3288	3202	3121	3012	2908	2800	2679	2521	2385	2230	2050	1839	1617	1281							
4	1200	3587	3507	3433	3343	3249	3145	3037	2926	2791	2659	2490	2364	2218	2037	1825	1568					
5	1300	3901	3835	3761	3664	3594	3507	3418	3319	3202	3104	2969	2864	2735	2581	2417	2230	2098	1928			
6	1400	4244	4182	4120	4057	3974	3896	3809	3727	3629	3536	3455	3326	3224	3110	2983	2833	2718	2581	2440	2293	
7	1550	4812	4738	4664	4587	4504	4438	4372	4291	4226	4134	4046	3962	3870	3780	3707	3579	3501	3404	3305	3204	3101
8	1700	5329	5262	5195	5139	5082	5020	4958	4895	4831	4752	4673	4601	4529	4455	4380	4294	4222	4145	4068	3990	3911
9	1800	5666	5607	5548	5481	5414	5353	5291	5221	5151	5086	5020	4953	4886	4811	4735	4671	4596	4523	4450	4375	4300
10	1900	6018	5957	5895	5833	5770	5712	5654	5589	5524	5463	5402	5340	5278	5208	5138	5047	4976	4907	4837	4766	4695
11	2000	6350	6287	6224	6165	6105	6045	5985	5923	5861	5799	5736	5672	5607	5541	5475	5414	5347	5281	5214	5148	5080
12	2160	6862	6805	6748	6698	6647	6588	6529	6477	6425	6364	6303	6249	6194	6131	6068	5987	5920	5854	5787	5721	5653

Fan selection is accomplished through the Aurora Controls and allows four online selections of continuous fan (G), L = stage 1 (Y1), 3/30/21

H = stage 2 (Y2), and Aux = electric heat.

Continuous Fan (G) can be set at any airflow. Factory setting is 1.

L = Stage 1 (Y1) factory setting is 3.

H = Stage 2 (Y2) factory setting is 9.

Electric Heat Operation (AUX) = Stage 3 factory setting is 10.

Elect heat Airflow (AUX) airflow setting should be configured for the minimum airflow needed to support the heater. Please consult heater manual.

# Blower Performance Data cont.

## Model 240

Fan Speed	Fan RPM	Airflow [cfm] at External Static Pressure [in. wg.]																				
		0.0	0.1	0.2	0.3	0.4	0.5	0.6	0.7	0.8	0.9	1.0	1.1	1.2	1.3	1.4	1.5	1.6	1.7	1.8	1.9	2.0
1	900	5755	5525	5290	5005	4725	5045	4075	3645	3205	2635											
2	1000	6610	6345	6080	5815	5550	5285	5020	4725	4425	4035	3640	3155									
3	1100	7465	7165	6870	6625	6375	5525	5965	5805	5400	5105	4810	4440	4075	3495	2915						
4	1200	7815	7650	7485	7295	7105	6915	6725	6540	6355	6095	5835	5540	5245	4755	4265	3995	3730	3075			
5	1300	8505	8355	8205	8040	7875	7705	7530	7335	7145	6925	6710	6505	6300	5975	5655	5165	4681	4568	4455	3870	3285
6	1400	9195	9020	8850	8705	8565	8395	8225	8060	7895	7710	7525	7355	7190	6975	6760	6380	6000	5500	5000	4600	4200
7	1500	9885	9785	9605	9470	9335	9180	9025	8895	8770	8575	8385	8215	8045	7850	7655	7415	7175	6740	6305	5870	5435
8	1600	10575	10545	10360	10235	10105	9930	9760	9605	9450	9325	9205	9045	8890	8725	8565	8385	8205	8005	7810	7565	7325
9	1700	11265	11105	11055	11000	10875	10680	10570	10435	10300	10160	10025	9880	9740	9590	9445	9275	9110	8880	8655	8275	7900
10	1800	11955	11860	11750	11695	11645	11430	11380	11265	11150	10995	10715	10595	10480	10340	10205	10065	9930	9770	9610	9305	9005
11	1900	12645	12615	12445	12390	12285	12180	12105	12085	12000	11830	11405	11310	11220	11090	10975	10845	10715	10565	10420	10280	10145
12	2000	13335	13230	13140	13085	12925	12885	12830	12755	12705	12665	12395	12025	11960	11840	11745	11625	11500	11360	11225	11085	10945

Fan selection is accomplished through the Aurora Controls and allows four online selections of continuous fan (G), L = stage 1 (Y1), H = stage 2 (Y2), and Aux = electric heat. 3/30/21

Continuous Fan (G) can be set at any airflow. Factory setting is 1.

L = Stage 1 (Y1) factory setting is 3.

H = Stage 2 (Y2) factory setting is 6.

Electric Heat Operation (AUX) = Stage 3 factory setting is 8.

Elect heat Airflow (AUX) airflow setting should be configured for the minimum airflow needed to support the heater. Please consult heater manual.

## Model 300

Fan Speed	Fan RPM	Airflow [cfm] at External Static Pressure [in. wg.]																				
		0.0	0.1	0.2	0.3	0.4	0.5	0.6	0.7	0.8	0.9	1.0	1.1	1.2	1.3	1.4	1.5	1.6	1.7	1.8	1.9	2.0
1	900	5755	5525	5290	5005	4725	5045	4075	3645	3205	2635											
2	1000	6610	6345	6080	5815	5550	5285	5020	4725	4425	4035	3640	3155									
3	1100	7465	7165	6870	6625	6375	5525	5965	5805	5400	5105	4810	4440	4075	3495	2915						
4	1200	7815	7650	7485	7295	7105	6915	6725	6540	6355	6095	5835	5540	5245	4755	4265	3995	3730	3075			
5	1300	8505	8355	8205	8040	7875	7705	7530	7335	7145	6925	6710	6505	6300	5975	5655	5165	4681	4568	4455	3870	3285
6	1400	9195	9020	8850	8705	8565	8395	8225	8060	7895	7710	7525	7355	7190	6975	6760	6380	6000	5500	5000	4600	4200
7	1500	9885	9785	9605	9470	9335	9180	9025	8895	8770	8575	8385	8215	8045	7850	7655	7415	7175	6740	6305	5870	5435
8	1600	10575	10545	10360	10235	10105	9930	9760	9605	9450	9325	9205	9045	8890	8725	8565	8385	8205	8005	7810	7565	7325
9	1700	11265	11105	11055	11000	10875	10680	10570	10435	10300	10160	10025	9880	9740	9590	9445	9275	9110	8880	8655	8275	7900
10	1800	11955	11860	11750	11695	11645	11430	11380	11265	11150	10995	10715	10595	10480	10340	10205	10065	9930	9770	9610	9305	9005
11	1900	12645	12615	12445	12390	12285	12180	12105	12085	12000	11830	11405	11310	11220	11090	10975	10845	10715	10565	10420	10280	10145
12	2000	13335	13230	13140	13085	12925	12885	12830	12755	12705	12665	12395	12025	11960	11840	11745	11625	11500	11360	11225	11085	10945

Fan selection is accomplished through the Aurora Controls and allows four online selections of continuous fan (G), L = stage 1 (Y1), H = stage 2 (Y2), and Aux = electric heat. 3/30/21

Continuous Fan (G) can be set at any airflow. Factory setting is 1.

L = Stage 1 (Y1) factory setting is 3.

H = Stage 2 (Y2) factory setting is 8.

Electric Heat Operation (AUX) = Stage 3 factory setting is 9.

Elect heat Airflow (AUX) airflow setting should be configured for the minimum airflow needed to support the heater. Please consult heater manual.

## Model 360

Fan Speed	Fan RPM	Airflow [cfm] at External Static Pressure [in. wg.]																				
		0.0	0.1	0.2	0.3	0.4	0.5	0.6	0.7	0.8	0.9	1.0	1.1	1.2	1.3	1.4	1.5	1.6	1.7	1.8	1.9	2.0
1	900	5755	5525	5290	5005	4725	5045	4075	3645	3205	2635											
2	1000	6610	6345	6080	5815	5550	5285	5020	4725	4425	4035	3640	3155									
3	1100	7465	7165	6870	6625	6375	5525	5965	5805	5400	5105	4810	4440	4075	3495	2915						
4	1200	7815	7650	7485	7295	7105	6915	6725	6540	6355	6095	5835	5540	5245	4755	4265	3995	3730	3075			
5	1300	8505	8355	8205	8040	7875	7705	7530	7335	7145	6925	6710	6505	6300	5975	5655	5165	4681	4568	4455	3870	3285
6	1400	9195	9020	8850	8705	8565	8395	8225	8060	7895	7710	7525	7355	7190	6975	6760	6380	6000	5500	5000	4600	4200
7	1500	9885	9785	9605	9470	9335	9180	9025	8895	8770	8575	8385	8215	8045	7850	7655	7415	7175	6740	6305	5870	5435
8	1600	10575	10545	10360	10235	10105	9930	9760	9605	9450	9325	9205	9045	8890	8725	8565	8385	8205	8005	7810	7565	7325
9	1700	11265	11105	11055	11000	10875	10680	10570	10435	10300	10160	10025	9880	9740	9590	9445	9275	9110	8880	8655	8275	7900
10	1800	11955	11860	11750	11695	11645	11430	11380	11265	11150	10995	10715	10595	10480	10340	10205	10065	9930	9770	9610	9305	9005
11	1900	12645	12615	12445	12390	12285	12180	12105	12085	12000	11830	11405	11310	11220	11090	10975	10845	10715	10565	10420	10280	10145
12	2000	13335	13230	13140	13085	12925	12885	12830	12755	12705	12665	12395	12025	11960	11840	11745	11625	11500	11360	11225	11085	10945

Fan selection is accomplished through the Aurora Controls and allows four online selections of continuous fan (G), L = stage 1 (Y1), H = stage 2 (Y2), and Aux = electric heat. 3/30/21

Continuous Fan (G) can be set at any airflow. Factory setting is 1.

L = Stage 1 (Y1) factory setting is 4.

H = Stage 2 (Y2) factory setting is 9.

Electric Heat Operation (AUX) = Stage 3 factory setting is 10.

Elect heat Airflow (AUX) airflow setting should be configured for the minimum airflow needed to support the heater. Please consult heater manual.

## Blower Performance Data cont.

### Setting Blower Speed - Variable Speed ECM

The ABC board's Yellow Config LED will flash the current ECM blower speed selections for G, low, and high continuously with a short pause in between. The speeds can also be confirmed with the AID Tool under the Setup/ECM Setup screen. The Aux will not be flashed but can be viewed in the AID Tool. The ECM blower motor speeds can be field adjusted with or without using an AID Tool.

#### Variable speed ECM Setup without an AID Tool

The blower speeds for G only, Low (Y1), and High (Y2/Aux) can be adjusted directly at the Aurora ABC board which utilizes the push button (SW1) on the ABC board. This procedure is outlined in the ECM Configuration Mode portion of the Aurora 'Base' Control System section. The Aux cannot be set manually without an AID Tool.

#### Variable speed ECM Setup with an AID Tool

A much easier method utilizes the AID Tool to change the airflow using the procedure below. First navigate to the Setup screen and then select ECM Setup. This screen displays the current ECM settings. It allows the technician

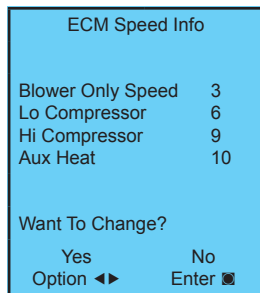

to enter the setup screens to change the ECM settings. Change the highlighted item using the ◀ and ▶ buttons and then press the ■ button to select the item.

Selecting YES will enter ECM speed setup, while selecting NO will return to the previous screen.

**ECM Speed Setup** - These screens allow the technician to select the G, low, high, and auxiliary heat blower speed for the ECM blower motor. Change the highlighted item using the ▲ and ▼ buttons. Press the ■ button to select the speed.

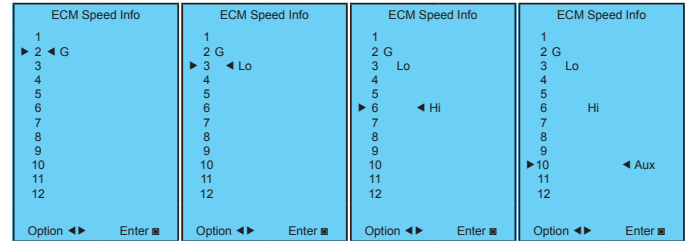

After the auxiliary heat speed setting is selected the AID Tool will automatically transfer back to the ECM Setup screen.

**Cooling Airflow Setup** - These screens allow the technician to select -15%, -10%, -5%, None or +5% change from the heating airflow. Change the adjustment percentage using the ▲ and ▼ buttons. Press the ■ button to save the change.

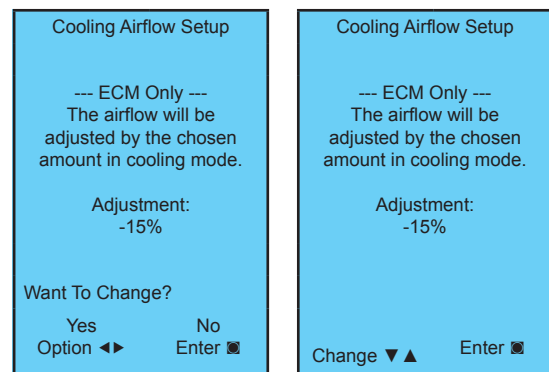

## Setting Blower Speed - Variable Speed ECM - UPC Controls

Variable speed ECM blower motors have 12 selectable speeds and are factory set for optimum performance. When applicable, the speed settings may also be adjusted through the Building Automation System (BAS).



**CAUTION: Disconnect all power before performing this operation.**

**Note: Not all factory installed options are available, please refer to WeDoGeo to see available options.**



## Antifreeze Corrections

Catalog performance can be corrected for antifreeze use. Please use the following table and note the example given.

Antifreeze Type	Antifreeze % by wt	Cooling Capacity	Heating Capacity	Pressure Drop
EWT - degF [DegC]		90 [32.2]	30 [-1.1]	30 [-1.1]
Water	0	1.000	1.000	1.000
Ethylene Glycol	10	0.991	0.973	1.075
	20	0.979	0.943	1.163
	30	0.965	0.917	1.225
	40	0.955	0.890	1.324
	50	0.943	0.865	1.419
Propylene Glycol	10	0.981	0.958	1.130
	20	0.969	0.913	1.270
	30	0.950	0.854	1.433
	40	0.937	0.813	1.614
	50	0.922	0.770	1.816
Ethanol	10	0.991	0.927	1.242
	20	0.972	0.887	1.343
	30	0.947	0.856	1.383
	40	0.930	0.815	1.523
	50	0.911	0.779	1.639
Methanol	10	0.986	0.957	1.127
	20	0.970	0.924	1.197
	30	0.951	0.895	1.235
	40	0.936	0.863	1.323
	50	0.920	0.833	1.399

**Warning:** Gray area represents antifreeze concentrations greater than 35% by weight and should be avoided due to the extreme performance penalty they represent.

### Antifreeze Correction Example

Antifreeze solution is Propylene Glycol 20% by weight. Determine the corrected full load heating and cooling performance at 30°F and 90°F respectively as well as pressure drop at 30°F for a \*120 model.

The corrected cooling capacity at 90°F would be: 117,200 Btu/h x 0.969 = 113,567 Btu/h

The corrected heat capacity at 30°F would be: 86,200 Btu/h x 0.913 = 78,701 Btu/h

The corrected pressure drop at 30°F and 30gpm would be: 6.9 ft. hd. x 1.270 = 8.8 ft. hd.

## Correction Factor Tables

### Air Flow Corrections (Part Load)

Airflow		Cooling				Heating		
CFM Per Ton of Clg	% of Nominal	Total Cap	Sens Cap	Power	Heat of Rej	Htg Cap	Power	Heat of Ext
240	60	0.922	0.778	0.956	0.924	0.943	1.239	0.879
275	69	0.944	0.830	0.962	0.944	0.958	1.161	0.914
300	75	0.957	0.866	0.968	0.958	0.968	1.115	0.937
325	81	0.970	0.900	0.974	0.970	0.977	1.075	0.956
350	88	0.982	0.933	0.981	0.980	0.985	1.042	0.972
375	94	0.991	0.968	0.991	0.991	0.993	1.018	0.988
<b>400</b>	<b>100</b>	<b>1.000</b>	<b>1.000</b>	<b>1.000</b>	<b>1.000</b>	<b>1.000</b>	<b>1.000</b>	<b>1.000</b>
425	106	1.007	1.033	1.011	1.008	1.007	0.990	1.010
450	113	1.013	1.065	1.023	1.015	1.012	0.987	1.018
475	119	1.017	1.099	1.037	1.022	1.018	0.984	1.025
500	125	1.020	1.132	1.052	1.027	1.022	0.982	1.031
520	130	1.022	1.159	1.064	1.030	1.025	0.979	1.034

1/4/18

### Air Flow Corrections (Full Load)

Airflow		Cooling				Heating		
CFM Per Ton of Clg	% of Nominal	Total Cap	Sens Cap	Power	Heat of Rej	Htg Cap	Power	Heat of Ext
240	60	0.922	0.786	0.910	0.920	0.943	1.150	0.893
275	69	0.944	0.827	0.924	0.940	0.958	1.105	0.922
300	75	0.959	0.860	0.937	0.955	0.968	1.078	0.942
325	81	0.971	0.894	0.950	0.967	0.977	1.053	0.959
350	88	0.982	0.929	0.964	0.978	0.985	1.031	0.973
375	94	0.992	0.965	0.982	0.990	0.993	1.014	0.988
<b>400</b>	<b>100</b>	<b>1.000</b>	<b>1.000</b>	<b>1.000</b>	<b>1.000</b>	<b>1.000</b>	<b>1.000</b>	<b>1.000</b>
425	106	1.007	1.034	1.020	1.010	1.007	0.990	1.011
450	113	1.012	1.065	1.042	1.018	1.013	0.983	1.020
475	119	1.017	1.093	1.066	1.026	1.018	0.980	1.028
500	125	1.019	1.117	1.092	1.033	1.023	0.978	1.034
520	130	1.020	1.132	1.113	1.038	1.026	0.975	1.038

11/10/18

### Cooling Capacity Corrections

Entering Air WB °F	Total Clg Cap	Sensible Cooling Capacity Multipliers - Entering DB °F										Power Input	Heat of Rejection
		60	65	70	75	80	80.6	85	90	95	100		
55	0.898	0.723	0.866	1.048	1.185	*	*	*	*	*	*	0.985	0.913
60	0.912		0.632	0.880	1.078	1.244	1.260	*	*	*	*	0.994	0.927
65	0.967			0.694	0.881	1.079	1.085	1.270	*	*	*	0.997	0.972
66.2	0.983			0.655	0.842	1.040	1.060	1.232	*	*	*	0.999	0.986
<b>67</b>	<b>1.000</b>			0.616	0.806	<b>1.000</b>	1.023	1.193	1.330	*	*	<b>1.000</b>	<b>1.000</b>
70	1.053				0.693	0.879	0.900	1.075	1.250	1.404	*	1.003	1.044
75	1.168					0.687	0.715	0.875	1.040	1.261	1.476	1.007	1.141

11/10/09

### Heating Corrections

Ent Air DB °F	Htg Cap	Power	Heat of Ext
45	1.062	0.739	1.158
50	1.050	0.790	1.130
55	1.037	0.842	1.096
60	1.025	0.893	1.064
65	1.012	0.945	1.030
68	1.005	0.976	1.012
<b>70</b>	<b>1.000</b>	<b>1.000</b>	<b>1.000</b>
75	0.987	1.048	0.970
80	0.975	1.099	0.930

11/10/09

## Water Quality

Material		Copper	90/10 Cupronickel	316 Stainless Steel
pH	Acidity/Alkalinity	7 - 9	7 - 9	7 - 9
Scaling	Calcium and Magnesium Carbonate	(Total Hardness) less than 350 ppm	(Total Hardness) less than 350 ppm	(Total Hardness) less than 350 ppm
Corrosion	Hydrogen Sulfide	Less than 0.5 ppm (rotten egg smell appears at 0.5 ppm)	10 - 50 ppm	Less than 1 ppm
	Sulfates	Less than 125 ppm	Less than 125 ppm	Less than 200 ppm
	Chlorine	Less than 0.5 ppm	Less than 0.5 ppm	Less than 0.5 ppm
	Chlorides	Less than 20 ppm	Less than 125 ppm	Less than 300 ppm
	Carbon Dioxide	Less than 50 ppm	10 - 50 ppm	10 - 50 ppm
	Ammonia	Less than 2 ppm	Less than 2 ppm	Less than 20 ppm
	Ammonia Chloride	Less than 0.5 ppm	Less than 0.5 ppm	Less than 0.5 ppm
	Ammonia Nitrate	Less than 0.5 ppm	Less than 0.5 ppm	Less than 0.5 ppm
	Ammonia Hydroxide	Less than 0.5 ppm	Less than 0.5 ppm	Less than 0.5 ppm
	Ammonia Sulfate	Less than 0.5 ppm	Less than 0.5 ppm	Less than 0.5 ppm
	Total Dissolved Solids (TDS)	Less than 1000 ppm	1000 - 1500 ppm	1000 - 1500 ppm
	LSI Index	+0.5 to -0.5	+0.5 to -0.5	+0.5 to -0.5
Iron Fouling (Biological Growth)	Iron, FE <sup>2+</sup> (Ferrous) Bacterial Iron Potential	< 0.2 ppm	< 0.2 ppm	< 0.2 ppm
	Iron Oxide	Less than 1 ppm, above this level deposition will occur	Less than 1 ppm, above this level deposition will occur	Less than 1 ppm, above this level deposition will occur
Erosion	Suspended Solids	Less than 10 ppm and filtered for max. of 600 micron size	Less than 10 ppm and filtered for max. of 600 micron size	Less than 10 ppm and filtered for max. of 600 micron size
	Threshold Velocity (Fresh Water)	< 6 ft/sec	< 6 ft/sec	< 6 ft/sec

NOTES: Grains = ppm divided by 17  
mg/L is equivalent to ppm

2/22/12

### Water Quality Guidelines

In ground water situations where scaling could be heavy or where biological growth such as iron bacteria will be present, a closed loop system is recommended. The heat exchanger coils in ground water systems may, over a period of time, lose heat exchange capabilities due to a buildup of mineral deposits inside. These can be cleaned, but only by a qualified service mechanic, as special solutions and pumping equipment are required. Hot water generator coils can likewise become scaled and possibly plugged. In areas with extremely hard water, the owner should be informed that the heat exchanger may require occasional flushing. Failure to adhere to the guidelines in the water quality table could result in loss of warranty.

Units with cupronickel heat exchangers are recommended for open loop applications due to the increased resistance to build-up and corrosion, along with reduced wear caused by acid cleaning.

## Operating Limits

Fluid Limit	Cooling		Heating	
	°F	°C	°F	°C
Min Entering Water	35	1.7	40	4.4
Min Entering Brine	30	-1.1	20	-6.7
Min Leaving Brine	68	20.0	15	-9.4
Min Leaving Water	68	20.0	35	1.7
Max Entering Water/Brine	123	50.6	90	32.2
Max Leaving Water/Brine	130	54.4	85	29.4
Min Differential Temperature	7	3.9	5	2.8
Max Differential Temperature	30	16.7	20	11.1
Air Limit	°F	°C	°F	°C
Min Entering Air	50	10.0	40	4.4
Max Entering Air	110	43.3	80	26.7
Min Differential Temperature	7	3.9	5	2.8
Max Differential Temperature	30	16.7	20	11.1
Flow Rate Limit	gpm/ton	L/min-kW	gpm/ton	L/s-kW
Minimum flow rate	1.5	5.7	1.5	5.7
Maximum flow rate	4.5	17.0	4.5	17.0
Ambient Temperature	°F		°C	
Minimum Ambient	-10		-23.3	
Maximum Ambient	140		60.0	

**NOTE:** Minimum/maximum limits are only for start-up conditions, and are meant for bringing the space up to occupancy temperature. Units are not designed to operate at the minimum/maximum conditions on a regular basis. The operating limits are dependent upon three primary factors: 1) water temperature, 2) return air temperature, and 3) ambient temperature. When any of the factors are at the minimum or maximum levels, the other two factors must be at the normal level for proper and reliable unit operation.

7/27/17

## Operating Parameters

### First Stage Operation

Entering Water Temp °F	Water Flow gpm/ton	Cooling -- No Hot Water Generation					
		Suction Pressure psig	Discharge Pressure psig	Superheat	Subcooling	Water Temp Rise °F	Air Temp Drop °F DB
30	1.5	105 - 120	140 - 155	20 - 35	9 - 17	17 - 21	17 - 23
	3.0	100 - 115	115 - 130	20 - 35	9 - 17	8 - 12	17 - 23
50	1.5	125 - 140	205 - 225	12 - 20	8 - 14	17 - 21	17 - 23
	3.0	120 - 135	180 - 200	12 - 20	8 - 14	8 - 12	17 - 23
70	1.5	135 - 145	280 - 290	10 - 16	8 - 14	16 - 20	17 - 23
	3.0	133 - 143	250 - 260	10 - 16	8 - 14	9 - 13	17 - 23
90	1.5	142 - 152	345 - 355	8 - 12	8 - 14	14 - 20	17 - 23
	3.0	140 - 150	330 - 340	8 - 12	8 - 14	8 - 12	17 - 23
110	1.5	152 - 158	405 - 435	8 - 12	8 - 14	14 - 20	17 - 23
	3.0	148 - 153	390 - 420	8 - 12	8 - 14	8 - 12	17 - 23

Entering Water Temp °F	Water Flow gpm/ton	Heating -- No Hot Water Generation					
		Suction Pressure psig	Discharge Pressure psig	Superheat	Subcooling	Water Temp Drop °F	Air Temp Rise °F DB
30	1.5	76 - 84	270 - 285	8 - 12	3 - 10	5 - 9	12 - 16
	3.0	80 - 88	275 - 290	8 - 12	3 - 10	3 - 7	14 - 18
50	1.5	100 - 115	280 - 310	10 - 14	3 - 10	7 - 11	18 - 22
	3.0	105 - 120	290 - 315	10 - 14	3 - 10	5 - 9	20 - 24
70	1.5	135 - 150	310 - 325	12 - 16	3 - 10	8 - 12	24 - 28
	3.0	140 - 155	315 - 330	12 - 16	3 - 10	6 - 10	22 - 30
90	1.5	155 - 165	330 - 370	12 - 16	3 - 10	8 - 12	24 - 28
	3.0	160 - 170	340 - 380	12 - 16	3 - 10	6 - 10	22 - 30
110	1.5						
	3.0						

**Note:** Cooling performance based on entering air temperatures of 80° F DB, 67° F WB. Heating performance based on entering air temperature of 70° F DB.

10/1/10

## Operating Parameters cont.

### Second Stage Operation

Entering Water Temp °F	Water Flow gpm/ton	Cooling -- No Hot Water Generation					
		Suction Pressure psig	Discharge Pressure psig	Superheat	Subcooling	Water Temp Rise °F	Air Temp Drop °F DB
30	1.5	115 - 125	150 - 170	20 - 35	10 - 17	17 - 22	17 - 23
	3.0	105 - 120	130 - 145	20 - 35	10 - 17	8 - 10	17 - 23
50	1.5	130 - 140	215 - 235	12 - 20	8 - 14	16 - 22	17 - 23
	3.0	128 - 138	190 - 210	12 - 20	8 - 14	8 - 12	17 - 23
70	1.5	138 - 148	280 - 310	10 - 16	10 - 16	15 - 21	17 - 23
	3.0	136 - 146	250 - 280	10 - 16	8 - 14	7 - 13	17 - 23
90	1.5	145 - 155	350 - 380	9 - 14	10 - 16	14 - 20	17 - 23
	3.0	143 - 153	320 - 350	9 - 14	8 - 14	6 - 10	17 - 23
110	1.5	145 - 155	420 - 450	9 - 14	10 - 16	14 - 20	17 - 23
	3.0	143 - 153	405 - 435	9 - 14	8 - 14	6 - 10	17 - 23

Entering Water Temp °F	Water Flow gpm/ton	Heating -- No Hot Water Generation					
		Suction Pressure psig	Discharge Pressure psig	Superheat	Subcooling	Water Temp Drop °F	Air Temp Rise °F DB
30	1.5	73 - 85	270 - 305	8 - 14	3 - 10	6 - 10	15 - 21
	3.0	77 - 90	280 - 315	8 - 14	3 - 10	4 - 8	17 - 23
50	1.5	97 - 110	290 - 325	10 - 16	3 - 10	9 - 13	22 - 28
	3.0	102 - 115	300 - 335	10 - 16	3 - 10	7 - 11	24 - 30
70	1.5	130 - 145	320 - 355	13 - 19	3 - 10	10 - 14	30 - 36
	3.0	135 - 150	325 - 360	13 - 19	3 - 10	8 - 12	32 - 38
90	1.5	150 - 160	350 - 390	13 - 19	3 - 10	10 - 14	30 - 36
	3.0	155 - 165	365 - 405	13 - 19	3 - 10	8 - 12	32 - 38
110	1.5						
	3.0						

Note: Cooling performance based on entering air temperatures of 80° F DB, 67° F WB.  
 Heating performance based on entering air temperature of 70° F DB.

10/1/10

## Operation Logic Data Table

Operation Logic Table	Heating					Cooling			
	STG1	STG2	STG3	EMERG	Fan Only	STG1	STG2	Reheat	Fan Only
Compressor	On	On	On	Off	Off	On	On	On	Off
Reversing Valve	Off	Off	Off	Off	Off	On	On	On	On
Aux Heat	Off	Off	Staged	Staged	Off	Off	Off	Off	Off
Acc Relay	On	On	On	Off	Off	On	On	On	Off
Fan Relay (PSC)	On	On	On	On	On	On	On	On	On
Loop Pump	On	On	On	Off	Off	On	On	On	Off
Hot Water	On	On	Off	Off	Off	On	On	NA	Off
5-Speed ECM Speed	Med Low	Med High	High	High	Low	Med Low	Med High	High	Low
ECM Speed	Med	High	Aux	Aux	Low	Med	High	High	Low
T-Stat Signal	Y1	Y1,Y2	Y1,Y2,W	W	G	Y1,O	Y1,Y2,O	DH	G

5/11/10

## Pressure Drop

Model		GPM	Pressure Drop (psi)				
			30°F	50°F	70°F	90°F	110°F
Dual Capacity Compressor	084	10.0	1.7	1.5	1.3	1.0	0.8
		16.0	3.5	3.3	3.1	2.9	2.7
		22.0	7.1	6.0	5.33	4.9	4.7
	096	12.0	1.4	1.2	1.0	0.8	0.6
		18.0	2.8	2.6	2.4	2.2	2.0
		24.0	4.9	4.6	4.4	4.2	4.0
	120	16.0	0.8	0.7	0.7	0.6	0.5
		22.0	1.5	1.3	1.2	1.2	1.1
		30.0	3.0	2.8	2.6	2.4	2.2
Two Compressor	150	24.0	3.2	3.0	2.8	2.6	2.4
		30.0	5.1	4.9	4.7	4.5	4.3
		36.0	6.9	6.7	6.5	6.3	6.1
	180	22.0	1.8	1.6	1.4	1.2	1.0
		34.0	3.0	2.8	2.6	2.4	2.2
		45.0	4.2	4.0	3.6	3.3	3.1
	240	35.0	1.8	1.6	1.5	1.4	1.2
		50.0	3.0	2.8	2.6	2.4	2.2
		60.0	6.0	5.8	5.6	5.3	5.1
	300	35.0	2.8	2.6	2.4	2.2	2.0
		50.0	4.2	4.0	3.8	3.6	3.4
		75.0	7.6	7.3	7.0	6.4	6.0
	360	50.0	3.4	3.2	3.0	2.8	2.6
		70.0	6.1	5.9	5.7	5.5	5.3
		90.0	8.7	8.5	8.3	8.1	7.9



3/30/21

# Aurora Control System

**Note: Not all factory installed options are available, please refer to WeDoGeo to see available options.**

## Aurora Controls

The Aurora Control System is a complete commercial comfort system that can bring all aspects of the HVAC system into one cohesive module network. The Aurora System is available in two configurations: Aurora Base Control and Aurora Advanced and Aurora Premium Control both with optional Aurora UPC for DDC applications.

Control	General Description	Application	Display/Interface	Protocol
<p><b>Aurora Base Control</b></p> 	<p>The ABC microprocessor provides all the features necessary to operate today's standard WSHPs that utilize dual capacity compressors and variable speed ECM/5 speed ECM blower motors with hot gas reheat. This control can communicate to a handheld diagnostic tool to help the installing contractor or service technician with equipment setup and service. By utilizing Modbus RTU communication protocol, the ABC board can communicate with additional devices on the Aurora network</p>	<p>Used for residential and commercial applications that use single or dual capacity compressors with PSC, 5-speed ECM, or variable speed ECM blower motors. This base control can also communicate to the AID Tool to display faults, inputs/outputs, and software revision. Commercial features such as hot gas reheat, slow opening water valve, and random start are also capable with the ABC board.</p>	<p>Optional AID tool can be used for field service.</p>	<p>Standalone</p>
<p><b>Aurora Advanced and Premium</b></p> 	<p>Aurora Advanced Control adds the Aurora AXB expansion board and provides added I/O and standard features such as refrigerant, performance or energy monitoring.</p>	<ul style="list-style-type: none"> <li>• <b>Refrigeration Monitoring</b> - provides Suction and discharge pressure, Suction, liquid line temps and superheat and subcooling.</li> <li>• <b>Performance Monitoring</b> - provides entering and leaving loop water temperatures, loop flow rate as well as heat of extraction or rejection rate into the loop.</li> <li>• <b>Energy Monitoring</b> - provides real-time power measurement (Watt) of compressor, fan, auxiliary heat and zone pump.</li> <li>• Plus many more I/O options</li> </ul>	<p>Optional AID tool can be used for field service.</p>	<p>Standalone</p>
<p><b>Aurora Base/Aurora Advanced Control w/UPC BACnet or N2</b></p> 	<p>The Aurora Unitary Protocol Converter (UPC) is an integrated solution and communicates directly with the Aurora Heat Pump Controls and allows access/control of a variety of internal Aurora heat pump operations such as sensors, relay operation, faults and other information. In turn, the UPC then converts internal Aurora Modbus protocol to BACnet MS/TP, or N2 protocols and communicates to the BAS system. This provides the great benefit of complete control integration and a myriad of information available to the BAS from the heat pump control. Plus it also allows individual unit configuration such as ECM fan speeds or freeze protection setting directly over the BAS without the need for access to the actual heat pump.</p>	<p>The Aurora UPC is implemented with the Aurora heat pump control into our latest water source heat pumps. All Internal Aurora points are accessible to the UPC via firmware providing an integrated solution. All zone temperatures and zone sensors are connected to the UPC on an RNet bus, simplifying hook up at the unit. RNet sensors can include a combination of zone temperature and humidity, CO2, and VOC sensors. The UPC includes built-in support for a custom configurable keypad/display unit.</p>	<p>Optional Aurora Touch</p>	<p>BACnet MS/TP or N2 Open (DIP selectable)</p>

## Aurora Control System cont.

**Note:** Not all factory installed options are available, please refer to WeDoGeo to see available options.

### Aurora 'Base' Control



**NOTE:** Refer to the Aurora Base Control Application and Troubleshooting Guide and the Instruction Guide: Aurora Interface and Diagnostics (AID) Tool for additional information.

**The Aurora Base Control** provides all baseline operation of 7 faults (HP, LP and LOC, coax freeze protection, air coil Freeze protection, over/under Voltage and condensate overflow), as well as compressor and fan speed and lockout management through the single ABC board (Aurora Base Control). The control features all heat pump operational timings, configurations, sensors and fault history that can be viewed using then AID tool.

### Optional Aurora UPC

When coupled with the optional Aurora UPC, the system can communicate all of these same heat pump parameters to the BAS as network points using either BACnet or N2. This means that not only are heat pump parameters visible by the BAS, many configuration settings, such as airflow and freeze detection settings, can also be changed from the BAS system saving commissioning costs. This provides both cost advantages and features not typically found on WSHP controls. All configuration, sensor and servicing can be accessed thru the AuroraTouch color service tool. This integration allows heat pump monitoring sensors, status and service diagnosis faults to be communicated thru the DDC direct to the building automation system (BAS), giving building supervisors detailed and accurate information on every piece of equipment without removing an access panel!

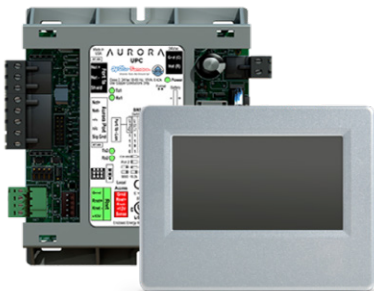

### Control Features

#### **Software ABC Standard Version 4.0**

#### **Single or Dual Capacity Compressors**

Either single or dual capacity compressors can be operated.

#### **Variable Speed ECM**

#### **Blower Motor Option (If Applicable)**

A Variable Speed ECM blower motor can be driven directly using the onboard PWM output. Four blower speeds are available based upon the G, Y1, Y2, and W input signals to the board. The blower speeds can be changed either by the ECM manual configurations mode method or by using the Aurora AID Tool directly. All four blower speeds can be set to the same speed if desired.

#### **5-Speed ECM Blower Motor Option (If Applicable)**

A 5-Speed ECM blower motor will be driven directly using the thermostat connections. Any of the G, Y1, or Y2/W signals can drive any of the 5 available pre-programmed blower speeds on the motor.

### Other Control Features

- Random start at power up
- Anti-short cycle protection
- High and low pressure cutouts
- Loss of charge
- Water coil freeze detection
- Air coil freeze detection
- Over/under voltage protection
- Condensate overflow sensor
- Load shed
- Dehumidification (where applicable)
- Emergency shutdown
- Hot gas reheat operation (where applicable)
- Diagnostic LED
- Test mode push button switch
- Two auxiliary electric heat outputs
- Alarm output
- Accessory output with N.O. and N.C.
- Modbus communication (master)
- Modbus communication (slave)



## Aurora Control System cont.

### Field Selectable Options via Hardware

**DIP Switch (SW1)** – Test/Configuration Button (See SW1 Operation Table)

#### Test Mode

The control is placed in the test mode by holding the push button switch SW1 for 2 - 5 seconds. In test mode most of the control timings will be shortened by a factor of sixteen (16). LED3 (green) will flash at 1 second on and 1 second off. Additionally, when entering test mode LED1 (red) will flash the last lockout one time. Test mode will automatically time out after 30 minutes. Test mode can be exited by pressing and holding the SW1 button for 2 to 5 seconds or by cycling the power. **NOTE:** Test mode will automatically be exited after 30 minutes.

#### Variable Speed ECM Configuration Mode (If Applicable)

The control is placed in the ECM configuration mode by holding the pushbutton switch SW1 for 5 to 10 seconds, the high, low, and “G” ECM speeds can be selected by following the LED display lights. LED2 (yellow) will fast flash when entering the ECM configuration. When setting “G” speed LED3 (green) will be continuously lit, for low speed LED1 (red) will be continuously lit, and for high speed both LED3 (green) and LED1 (red) will be continuously lit. During the ECM configuration mode LED2 (yellow) will flash each of the 12 possible blower speeds 3 times. When the desired speed is flashed press SW1, LED2 will fast flash until SW1 is released. “G” speed has now been selected. Next select low speed, and high speed blower selections following the same process above. After third selection has been made, the control will exit the ECM configuration mode. Aux fan speed will remain at default or current setting and requires the AID Tool for adjustment.

#### Reset Configuration Mode

The control is placed in reset configuration mode by holding the push button switch SW1 for 50 to 60 seconds. This will reset all configuration settings and the EEPROM back to the factory default settings. LED3 (green) will turn off when entering reset configuration mode. Once LED3 (green) turns off, release SW1 and the control will reset.

### DIP Switch (SW2)

- SW2-1** FP1 Selection – Low water coil temperature limit setting for freeze detection. On = 30°F; Off = 15°F.  
**SW2-2** FP2 Selection – On = 30°F; Off = N/A  
**SW2-3** RV – O/B - thermostat type. Heat pump thermostats with “O” output in cooling or “B” output in Heating can be selected. On = O; Off = B.  
**SW2-4** Access Relay Operation (P2)  
**and 2-5**

Access Relay Operation	SW2-4	SW2-5
Cycle with Blower	ON	ON
Cycle with Compressor	OFF	OFF
Water Valve Slow Opening	ON	OFF
Cycle with Comm. T-stat Hum Cmd	OFF	ON

**Cycle with Blower** - The accessory relay will cycle with the blower output.

**Cycle with Compressor** - The accessory relay will cycle with the compressor output.

**Water Valve Slow Opening** - The accessory relay will cycle and delay both the blower and compressor output for 90 seconds.

- SW2-6** CC Operation – selection of single or dual capacity compressor. On = Single Stage; Off = Dual Capacity  
**SW2-7** Lockout and Alarm Outputs (P2) – selection of a continuous or pulsed output for both the LO and ALM Outputs. On = Continuous; Off = Pulsed  
**SW2-8** *Future Use*

#### Alarm Jumper Clip Selection

From the factory, ALM is connected to 24 VAC via JW2. By cutting JW2, ALM becomes a dry contact connected to ALG.

#### Variable Speed ECM Blower Speeds

The blower speeds can be changed either by using the ECM manual configurations mode method or by using the Aurora AID Tool directly (see Instruction Guide: Aurora Interface and Diagnostics (AID) Tool topic).

## Aurora Control System cont.

### Field Selectable Options via Software

*(Selectable via the Aurora AID Tool)*

#### ECM Blower Speeds

An ECM blower motor can be driven directly using the onboard PWM output. Four blower speeds are available, based upon the “G”, Y1 (low), Y2 (high), and Aux input signals to the board. The blower speeds can be changed either by the ECM manual configurations mode method (see ECM Configuration Mode topic) or by using the Aurora AID Tool directly. All four blower speeds can be set to the same speed if desired. Aux blower speed will remain at default or current setting and requires the AID Tool for adjustment.

#### Safety Features

The following safety features are provided to protect the compressor, heat exchangers, wiring and other components from damage caused by operation outside of design conditions.

**Fuse** – a 3 amp automotive type plug-in fuse provides protection against short circuit or overload conditions.

**Anti-Short Cycle Protection** – 4 minute anti-short cycle protection for the compressor.

**Random Start** – 5 to 80 second random start upon power up.

**Fault Retry** – in the fault condition, the control will stage off the outputs and then “try again” to satisfy the thermostat Y input call. Once the thermostat input calls are satisfied, the control will continue on as if no fault occurred. If 3 consecutive faults occur without satisfying the thermostat Y input call, then the control will go to Lockout mode.

**Lockout** – when locked out, the blower will operate continuously in “G” speed, and PSC blower motor output will remain on. The Alarm output (ALM) and Lockout output (L) will be turned on. The fault type identification display LED1 (Red) shall flash the fault code. To reset lockout conditions with SW2-8 On, thermostat inputs “Y1”, “Y2”, and “W” must be removed for at least 3 seconds. To reset lockout conditions with SW2-8 Off, thermostat inputs “Y1”, “Y2”, “W”, and “DH” must be removed for at least 3 seconds. Lockout may also be reset by turning power off for at least 30 seconds or by enabling the emergency shutdown input for at least 3 seconds.

**Lockout With Emergency Heat** – if the control is locked out in the heating mode, and a Y2 or W input is received, the control will operate in the emergency heat mode while the compressor is locked out. The first emergency heat output will be energized 10 seconds after the W input is received, and the blower will shift to high speed. If the control remains locked out, and the W input is present, additional stage of emergency heat will stage on after 2 minutes. When the W input is

removed, all of the emergency heat outputs will turn off, and the ECM blower will shift to “G” speed and PSC blower motor output will remain on.

**High Pressure** – fault is recognized when the Normally Closed High Pressure Switch, P4-9/10 opens, no matter how momentarily. The High Pressure Switch is electrically in series with the Compressor Contactor and serves as a hard-wired limit switch if an overpressure condition should occur.

**Low Pressure** – fault is recognized when the Normally Closed Low Pressure Switch, P4-7/8 is continuously open for 30 seconds. Closure of the LPS any time during the 30 second recognition time restarts the 30 second continuous open requirement. A continuously open LPS shall not be recognized during the 2 minute startup bypass time.

**Loss of Charge** – fault is recognized when the Normally Closed Low Pressure Switch, P4-7/8 is open prior to the compressor starting.

**Condensate Overflow** – fault is recognized when the impedance between this line and 24 VAC common or chassis ground drops below 100K ohms for 30 seconds continuously.

**Freeze Detection (Coax)** – set points shall be either 30°F or 15°F. When the thermistor temperature drops below the selected set point, the control shall begin counting down the 30 seconds delay. If the thermistor value rises above the selected set point, then the count should reset. The resistance value must remain below the selected set point for the entire length of the appropriate delay to be recognized as a fault. This fault will be ignored for the initial 2 minutes of the compressor run time.

**Freeze Detection (Air Coil)** – uses the FP2 input to protect against ice formation on the air coil. The FP2 input will operate exactly like FP1 except that the set point is 30 degrees and is not field adjustable.

**Over/Under Voltage Shutdown** – An over/under voltage condition exists when the control voltage is outside the range of 18 VAC to 30 VAC. If the over/under voltage shutdown lasts for 15 minutes, the lockout and alarm relay will be energized. Over/under voltage shutdown is self-resetting in that if the voltage comes back within range of 18 VAC to 30 VAC for at least 0.5 seconds, then normal operation is restored.

## Aurora Control System cont.

### Operation Description

**Power Up** - The unit will not operate until all the inputs and safety controls are checked for normal conditions. The unit has a 5 to 80 second random start delay at power up. Then the compressor has a 4 minute anti-short cycle delay after the random start delay.

**Standby** In standby mode, Y1, Y2, W, DH, and G are not active. Input O may be active. The blower and compressor will be off.

### Heating Operation

#### **Single Compressor Heating, 2nd Stage (Y1, Y2)**

The compressor will be staged to full capacity 20 seconds after Y2 input is received. The ECM blower will shift to high speed seconds after the Y2 input is received.

#### **Dual Compressor Heating, 2nd Stage (Y1, Y2)**

In dual compressor operation, two ABC boards used in 24 VAC operation, there will be a Y2 call to the Y1 input on the second ABC. The compressor will stage to full capacity 30 seconds after Y1 input is received to the second board.

#### **Single Compressor Heating, 3rd Stage (Y1, Y2, W)**

The hot water pump is de-energized and the first stage of electric heat is energized 10 seconds after the W command is received. If the demand continues the second stage of electric heat will be energized after 5 minutes.

#### **Dual Compressor Heating, 3rd Stage (Y1, Y2, W) -**

The first stage of electric heat is energized 10 seconds after the W command is received. If the demand continues the second stage of electric heat will be energized after 5 minutes

**Emergency Heat (W)** - The blower will be started on "G" speed, 10 seconds later the first stage of electric heat will be turned on. 5 seconds after the first stage of electric heat is energized the blower will shift to Aux speed. If the emergency heat demand is not satisfied after 2 minutes the second electric heat stage will be energized.

**Blower (G)** - The blower will start immediately upon receiving a thermostat G command. If there are no other commands from the thermostat the ECM will run on "G" speed until the G command is removed. Regardless of blower input (G) from the thermostat, the blower will remain on for 30 seconds at the end of each heating cycle.

### Cooling Operation

In all cooling operations, the reversing valve directly tracks the O input. Thus, anytime the O input is present, the reversing valve will be energized.

#### **Single Compressor Cooling, 2nd Stage (Y1, Y2, O)**

The compressor will be staged to full capacity 20 seconds after Y2 input was received. The ECM blower will shift to high speed 15 seconds after the Y2 input was received.

#### **Dual Compressor Cooling, 2nd Stage (Y1, Y2, O)**

In dual compressor operation, two ABC boards used in 24 VAC operation, there will be a Y2 call to the Y1 input on the second ABC. The compressor will stage to full capacity 30 seconds after Y1 input is received to the second board.

**Blower (G)** - The blower will start immediately upon receiving a thermostat G command. If there are no other commands from the thermostat the ECM will run on "G" speed until the G command is removed. Regardless of blower input (G) from the thermostat, the blower will remain on for 30 seconds at the end of each heating, cooling, and emergency heat cycle.

**Dehumidification (Y1, O, DH or Y1, Y2, O, DH)** - When a DH command is received from the thermostat during a compressor call for cooling the ECM blower speed will be reduced by 15% to increase dehumidification.

**Emergency Shutdown** - Four (4) seconds after a valid ES input, P2-7 is present, all control outputs will be turned off and remain off until the emergency shutdown input is no longer present. The first time that the compressor is started after the control exits the emergency shutdown mode, there will be an anti-short cycle delay followed by a random start delay. Input must be tied to common to activate.

**Continuous Blower Operation** - The blower output will be energized any time the control has a G input present, unless the control has an emergency shutdown input present. The blower output will be turned off when G input is removed.

**Load Shed** - The LS input disables all outputs with the exception of the blower output. When the LS input has been cleared, the anti-short cycle timer and random start timer will be initiated. Input must be tied to common to activate.

# Aurora Control System cont.

## Aurora ‘Base’ Control LED Displays

These three LEDs display the status, configuration, and fault codes for the control. These can also be read in plain English via the Aurora AID Tool.

### Status LED (LED3, Green)

Description of Operation	Fault LED, Green
Normal Mode	ON
Control is Non-functional	OFF
Test Mode	Slow Flash
Lockout Active	Fast Flash
Dehumidification Mode	Flash Code 2
(Future Use)	Flash Code 3
(Future Use)	Flash Code 4
Load Shed	Flash Code 5
ESD	Flash Code 6
(Future Use)	Flash Code 7

### Configuration LED (LED2, Yellow)

Description of Operation	Configuration LED, Yellow
No Software Overwritten	Flashing ECM Setting
DIP Switch was Overwritten	Slow Flash
ECM Configuration Mode	Fast Flash

### Fault LED (LED1, Red)

Red Fault LED	LED Flash Code*	Lockout	Reset/Remove
Normal - No Faults	OFF	-	
Fault - Input	1	No	Auto
Fault - High Pressure	2	Yes	Hard or Soft
Fault - Low Pressure	3	Yes	Hard or Soft
Fault - Freeze Detection FP2	4	Yes	Hard or Soft
Fault - Freeze Detection FP1	5	Yes	Hard or Soft
Fault - Condensate Overflow	7	Yes	Hard or Soft
Fault - Over/Under Voltage	8	No	Auto
Fault - FP1 & FP2 Sensor Error	11	Yes	Hard or Soft

**NOTE:** All codes >11 use long flash for tens digit and short flash for the ones digit. 20, 30, 40, 50, etc. are skipped.

## Aurora Interface and Diagnostics (AID) Tool

The Aurora Interface and Diagnostics (AID) Tool is a device that is a member of the Aurora network. The AID Tool is used to troubleshoot equipment which uses the Aurora control via Modbus RTU communication. The AID Tool provides diagnostics, fault management, ECM setup, and system configuration capabilities to the Aurora family of controls. An AID Tool is recommended, although not required, for ECM airflow settings. The AID Tool simply plugs into the ABC-A board.



## ABC Control Board Layout

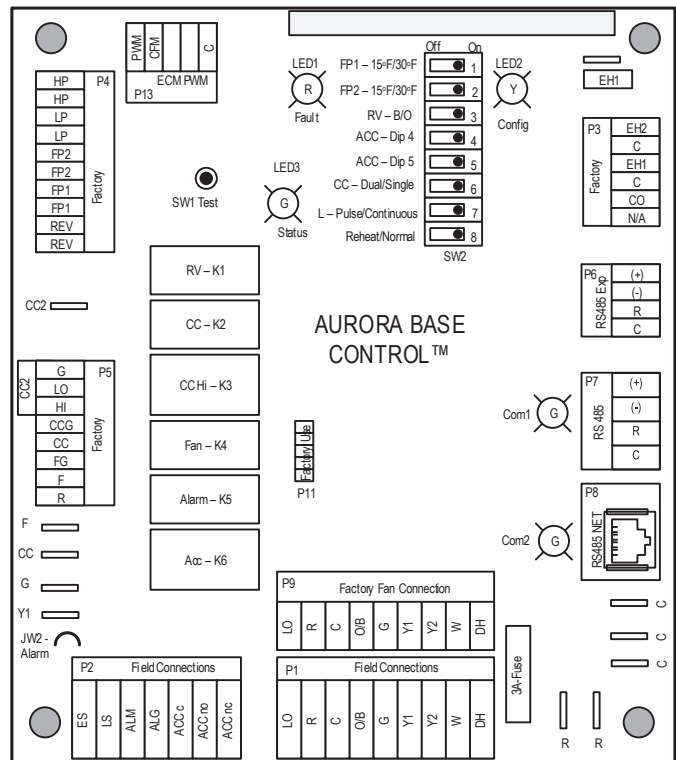

## Aurora Control System cont.

Note: Not all factory installed options are available, please refer to WeDoGeo to see available options.

### Aurora Advanced and Aurora Premium Controls



The **Aurora Advanced and Aurora Premium Control** provides all of the Aurora Base Control features plus it adds the extended I/O of the Aurora Expansion Board (AXB) to the mix. This extended I/O includes the energy monitoring where current transducers measure current and power of fan and compressor. Aurora Premium Controls add refrigeration monitoring kit that reports refrigerant temperatures and pressures and will calculate superheat and subcooling. The Premium package also includes performance kit for entering and leaving water temperature along with source water flow rate via optional field installed flow meter.

#### Optional Aurora UPC

When coupled with the optional Aurora UPC, can communicate all of these same heat pump parameters to the BAS as network points using either BACnet MS/TP or N2 protocols. This means that not only are heat pump parameters visible by the BAS, many configuration settings, such as airflow and freeze detection settings, can also be changed from the BAS system saving commissioning costs. All configuration, sensor and servicing can be accessed through the AuroraTouch color service tool. With the optional Advanced controls and the monitoring kits installed refrigeration, performance and energy consumption are all cost effectively transmitted to the BAS!

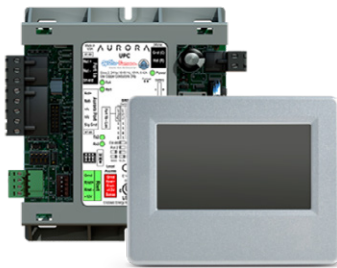

### Aurora Advanced And Aurora Premium Control Features

The Aurora 'Advanced' Control system expands on the capability of the Aurora 'Base' Control (ABC) by adding the Aurora Expansion Board (AXB). All of the preceding features of the Aurora 'Base' Control are included. The following control description is of the additional features and capability of the Aurora advanced control.

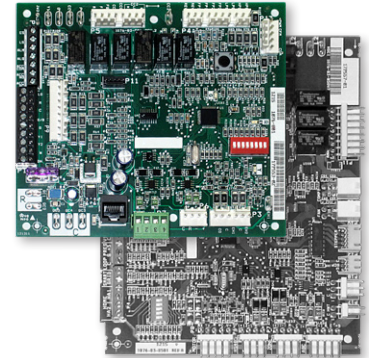

It is highly recommended the installing/servicing contractor obtain an Aurora Interface and Diagnostic Tool (AID) and specialized training before attempting to install or service an Aurora 'Advanced' control system.

The additional AXB features include the following:

#### Leaving Air Temperature Sensor

Standard on all Aurora Advanced Controls is a leaving air (discharge air) sensor. This sensor is pre-mounted for downflow applications and will need to be repositioned for side discharge applications in a high velocity location for best results

#### AXB DIP Switch

**DIP 1 - ID:** This is the AXB ModBus ID and should always read On.

**DIP 2 & 3 - Future Use**

**DIP 4 & 5 - Accessory Relay2:** A second, DIP configurable, accessory relay is provided that can be cycled with the compressor 1 or 2, blower, or the Dehumidifier (DH) input. This is to complement the Accessory 1 Relay on the ABC board.

Position	DIP 4	DIP 5	Description
1	ON	ON	Cycles with Fan or ECM (or G)
2	OFF	ON	Cycles with CC1 first stage of compressor or compressor spd 1-6
3	ON	OFF	Cycles with CC2 second stage of compressor or compressor spd 7-12
4	OFF	OFF	Cycles with DH input from ABC board

#### Compressor Monitoring

The AXB includes two current transducers to monitor the compressor current and starting characteristics. Open circuits or welded contactor faults will be detected. This fault will produce an E10 code.

## Aurora Control System cont.

### Variable Speed Pump

This input and output are provided to drive and monitor a variable speed pump. The VS pump output is a PWM signal to drive the variable speed pump. The minimum and maximum level are set using the AID Tool. 75% and 100% are the default settings respectively. The VS data input allows a separate PWM signal to return from the pump giving fault and performance information. Fault received from the variable speed pump will be displayed as E16. Consult factory for application assistance.

### Modulating Water Valve

This output is provided to drive a modulating water valve. Through advanced design the 0-10VDC valve can be driven directly from the VS pump output. The minimum and maximum level are set in the same way as the VS pump using the AID Tool. 75% and 100% are the default settings respectively.

### Advanced Communication Ports

Communication ports P6 and P8 will provide future expansion via dedicated protocols. These are for future use.

### Monitoring Sensor Kits

#### Energy Monitoring (Standard Sensor Kit on 'Advanced' models)

The Energy Monitoring Kit includes two current transducers (blower and electric heat) added to the existing two compressor sensors so that the complete power usage of the heat pump can be measured. The AID Tool provides configuration detail for the type of blower motor, power adjustment and a line voltage calibration procedure to improve the accuracy, and a power adjustment setting that allows the compressor power to be adjusted to match the unit's line voltage using the provided tables. This information can be displayed on the AID Tool or selected communicating thermostats. The TPCM32U03A/04A will display instantaneous energy use while the color touchscreen TPCC32U will in addition display a 13 month history in graph form. Refer to Unit Start Up Energy Monitoring for configuration details.

#### Refrigerant Monitoring (Standard with Premium Controls)

Refrigerant Monitoring Kit includes two pressure transducers, and three temperature sensors, heating liquid line, suction temperature and existing cooling liquid line (FP1). These sensors allow the measurement of discharge and suction pressures, suction and liquid line temperatures as well as superheat and subcooling. This information will only be displayed on the AID Tool.

### Performance Monitoring (Standard with Premium Controls)

Performance Monitoring Kit includes three temperature sensors, entering and leaving water, leaving air temperature and a water flow rate sensor. With this kit heat of extraction and rejection will be calculated. This requires configuration using the AID Tool for selection of water or antifreeze.

### AXB Control Board Layout

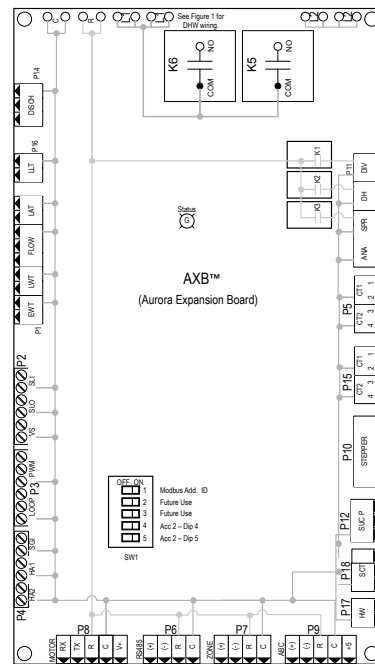

### Communicating Digital Thermostats

The Aurora controls system also features either monochromatic or color touch screen graphic display thermostats for user interface. These displays not only feature easy to use graphical interface but display alerts and faults in plain English. Many of the features discussed here may not be applicable without these thermostats.

### Dehumidification - Passive

In passive dehumidification mode, the airflow is reduced by 15% from the heating airflow setting. If cooling airflow is set to +5, -5 or -10% of heating airflow it will automatically be set to -15% of heating airflow whenever the dehumidification call is present in the communicating stat or from the thermostat input DH. If the airflow for cooling is already set to -15% no airflow change will be noticed from normal cooling. Dehumidification mode will be shown on the ABC and the communicating thermostats.

# Aurora Control System cont.

## Aurora ‘Advanced’ Control LED Displays

These three LEDs display the status, configuration, and fault codes for the control. These can also be read in plain English via the Aurora AID Tool.

### Status LED (LED3, Green)

Description of Operation	Fault LED, Green
Normal Mode	ON
Control is Non-functional	OFF
Test Mode	Slow Flash
Lockout Active	Fast Flash
Dehumidification Mode	Flash Code 2
Load Shed	Flash Code 5
Emergency Shutdown	Flash Code 6
On Peak Mode	Flash Code 7
(Future Use)	Flash Code 8
(Future Use)	Flash Code 9

### Configuration LED (LED2, Yellow)

Description of Operation	Configuration LED, Yellow
No Software Overwritten	ECM Setting
DIP Switch Overwritten	Slow Flash
ECM Configuration Mode	Fast Flash
Reset Configuration Mode	OFF

### Fault LED (LED1, Red)

Red Fault LED		LED Flash Code *	Lockout	Reset/ Remove	Fault Condition Summary
ABC Basic Faults	Normal - No Faults	Off	-		
	Fault-Input	1	No	Auto	Tstat input error. Autoreset upon condition removal.
	Fault-High Pressure	2	Yes	Hard or Soft	HP switch has tripped (>600 psi)
	Fault-Low Pressure	3	Yes	Hard or Soft	Low Pressure Switch has tripped (<40 psi for 30 continuous sec.)
	Fault-Freeze Detection FP2	4	Yes	Hard or Soft	Freeze protection sensor has tripped (<15 or 30 degF for 30 continuous sec.)
	Fault-Freeze Detection FP1	5	Yes	Hard or Soft	Freeze protection sensor has tripped (<15 or 30 degF for 30 continuous sec.)
	Fault-Condensate Overflow	7	Yes	Hard or Soft	Condensate switch has shown continuity for 30 continuous sec.
ABC & AXB Advanced Faults	Fault-Over/Under Voltage	8	No	Auto	Instantaneous voltage is out of range. **Controls shut down until resolved.
	Fault-FP1 Sensor Error	11	Yes	Hard or Soft	FP1 Sensor Open or Shorted
	Fault-Compressor Monitor	10	Yes	Hard or Soft	Open Crkt, Run, Start or welded cont
	Non-CriticAXB SnsrErr	13	No	Auto	Any Other Sensor Error
	CriticAXBSnsrErr	14	Yes	Hard or Soft	Sensor Error for EEV or HW
	Alert-HotWtr	15	No	Auto	HW over limit or logic lockout. HW pump deactivated.
	Fault-VarSpdPump	16	No	Auto	Alert is read from PWM feedback.
	Non-CritComErr	18	No	Auto	Any non-critical com error
	Fault-CritComErr	19	No	Auto	Any critical com error. Auto reset upon condition removal
	Alarm - Low Loop Pressure	21	No	Auto	Loop pressure is below 3 psi for more than 3 minutes
Alarm - Home Automation 1	23	No	Auto	Closed contact input is present on Dig 2 input - Text is configurable	
Alarm - Home Automation 2	24	No	Auto	Closed contact input is present on Dig 3 input - Text is configurable	

NOTES: \*All codes >11 use long flash for tens digit and short flash for the ones digit. 20, 30, 40, 50 etc. are skipped!  
Alert' is a noncritical sensor or function that has failed. Normal operation of the heat pump is maintained but service is desired at some point.

### Operation Logic Data Table

Operation Logic Table	Heating					Cooling			
	STG1	STG2	STG3	EMERG	Fan Only	STG1	STG2	Reheat	Fan Only
Compressor	On	On	On	Off	Off	On	On	On	Off
Reversing Valve	Off	Off	Off	Off	Off	On	On	On	On
Aux Heat	Off	Off	Staged	Staged	Off	Off	Off	Off	Off
Acc Relay	On	On	On	Off	Off	On	On	On	Off
Fan Relay (PSC)	On	On	On	On	On	On	On	On	On
Loop Pump	On	On	On	Off	Off	On	On	On	Off
Hot Water	On	On	Off	Off	Off	On	On	NA	Off
5-Speed ECM Speed	Med Low	Med High	High	High	Low	Med Low	Med High	High	Low
ECM Speed	Med	High	Aux	Aux	Low	Med	High	High	Low
T-Stat Signal	Y1	Y1,Y2	Y1,Y2,W	W	G	Y1,O	Y1,Y2,O	DH	G

## Refrigerant Circuit Guideline

Symptom	Head Pressure	Suction Pressure	Compressor Amp Draw	Superheat	Subcooling	Air Temp. Differential	Water Temp. Differential
Under Charged System (Possible Leak)	Low	Low	Low	High	Low	Low	Low
Over Charged System	High	High	High	Normal	High	Normal/Low	Normal
Low Air Flow Heating	High	High	High	High/Normal	Low	High	Low
Low Air Flow Cooling	Low	Low	Low	Low/Normal	High	High	Low
Low Water Flow Heating	Low/Normal	Low/Normal	Low	Low	High	Low	High
Low Water Flow Cooling	High	High	High	High	Low	Low	High
High Air Flow Heating	Low	Low	Low	Low	High	Low	Low
High Air Flow Cooling	Low	High	Normal	High	Low	Low	Normal
High Water Flow Heating	Normal	Low	Normal	High	Normal	Normal	Low
High Water Flow Cooling	Low	Low	Low	Low	High	Normal	Low
Low Indoor Air Temperature Heating	Low	Low	Low	Normal	High	Normal	Normal/High
Low Indoor Air Temperature Cooling	Low	Low	Low	Normal/Low	High	Low	Low
High Indoor Air Temperature Heating	High	High	High	Normal/High	Normal/Low	Low	Normal
High Indoor Air Temperature Cooling	High	High	High	High	Low	Low	High
Restricted EEC (Check Service Advisory)	High	Low	Normal/Low	High	High	Low	Low
Insufficient Compressor (Possible Bad Valves)	Low	High	Low	High	Normal/High	Low	Low
Scaled Coaxial Heat Exchanger Heating	Low	Low	Low	Normal/Low	High	Low	Low
Scaled Coaxial Heat Exchanger Cooling	High	High	High	Normal/Low	Low	Low	Low
Restricted Filter Drier	Check temperature difference (delta T) across filter drier.						

8/25/16



## System Cleaning and Flushing

### Cleaning and Flushing

Prior to start up of any heat pump, the water circulating system must be cleaned and flushed of all dirt and debris.

If the system is equipped with water shutoff valves, the supply and return runouts must be connected together at each unit location (This will prevent the introduction of dirt into the unit, see Flushing with Water Shutoff Valve Equipped Systems illustration). The system should be filled at the water make-up connection with all air vents open. After filling, vents should be closed.

#### Flushing with Water Shutoff Valve Equipped Systems

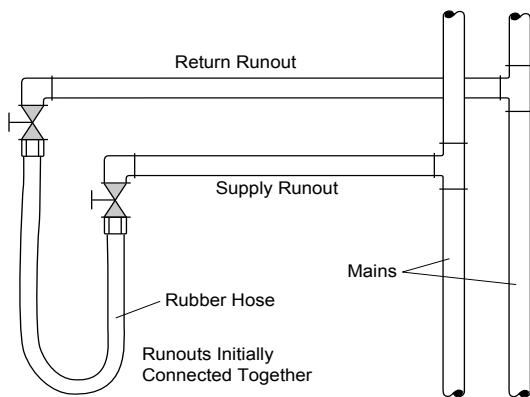

The contractor should start the main circulator with the pressure reducing valve makeup open. Vents should be checked in sequence to bleed off any trapped air and to verify circulation through all components of the system.

As water circulates through the system, the contractor should check and repair any leaks found in the piping system. Drain(s) at the lowest point(s) in the system should be opened for initial flush and blowdown, making sure water fill valves are set at the same rate. Check the pressure gauge at the pump suction and manually adjust the make-up water valve to hold the same positive pressure both before and after opening the drain valves. Flushing should continue for at least two hours, or longer if required, until drain water is clean and clear.

The supplemental heater and/or circulator pump, if used, should be shut off. All drains and vents should be opened to completely drain the system. Short-circuited supply and return runouts should now be connected to the unit supply and return connections.

Refill the system with clean water. Test the system water for acidity and treat as required to leave the water slightly alkaline (pH 7.5 to 8.5). The specified percentage of antifreeze may also be added at this time. Use commercial grade antifreeze designed for HVAC systems only. Environol™ brand antifreeze is recommended.

Once the system has been filled with clean water and antifreeze (if used), precautions should be taken to protect the system from dirty water conditions. Dirty water will result in system-wide degradation of performance, and solids may clog valves, strainers, flow regulators, etc. Additionally, the heat exchanger may become clogged which reduces compressor service life and can cause premature unit failure.

In boiler/tower application, set the loop control panel set points to desired temperatures. Supply power to all motors and start the circulating pumps. After full flow has been established through all components including the heat rejector (regardless of season), air vented and loop temperatures stabilized, each of the units will be ready for check, test and start up and for air and water balancing.

### Ground Source Loop System Checkout

Once piping is completed between the unit pumping system and ground loop, final purging and charging of the loop is needed. A high pressure pump is needed to achieve adequate flow velocity in the loop to purge air and dirt particles from the loop itself. Antifreeze solution is used in most areas to prevent freezing. Flush the system adequately to remove as much air as possible; then pressurize the loop to a static pressure of 40-50 PSI (summer) or 50-75 PSI (winter). This is normally adequate for good system operation. Loop static pressure may decrease soon after initial installation, due to pipe expansion and loop temperature change. Running the unit for at least 30 minutes after the system has been completely purged of air will allow for the “break-in” period. It may be necessary to adjust static loop pressure (by adding water) after the unit has run for the first time. Loop static pressure will also fluctuate with the seasons. Pressures will be higher in the winter months than during the cooling season. This fluctuation is normal and should be considered when charging the system initially.

Ensure the pump provides adequate flow through the unit by checking pressure drop across the heat exchanger. Usually 2.25-3.0 gpm of flow per ton of cooling capacity is recommended in earth loop applications.

## Open Loop Ground Water Systems

Typical open loop piping is shown below. Always maintain water pressure in the heat exchanger by placing water control valves at the outlet of the unit to prevent mineral precipitation. Use a closed, bladder-type expansion tank to minimize mineral formation due to air exposure. Insure proper water flow through the unit by checking pressure drop across the heat exchanger and comparing it to the figures in unit capacity data tables in the specification catalog. 1.5-2 gpm of flow per ton of cooling capacity is recommended in open loop applications. Due to only minor

differences in flow rate from low to high, only one solenoid valve should be used. The valve should be sized for full flow.

Discharge water from the unit is not contaminated in any manner and can be disposed of in various ways, depending on local codes, i.e. recharge well, storm sewer, drain field, adjacent stream or pond, etc. Most local codes forbid the use of sanitary sewer for disposal. Consult your local building and zoning departments to assure compliance in your area.

### Open System - Groundwater Application

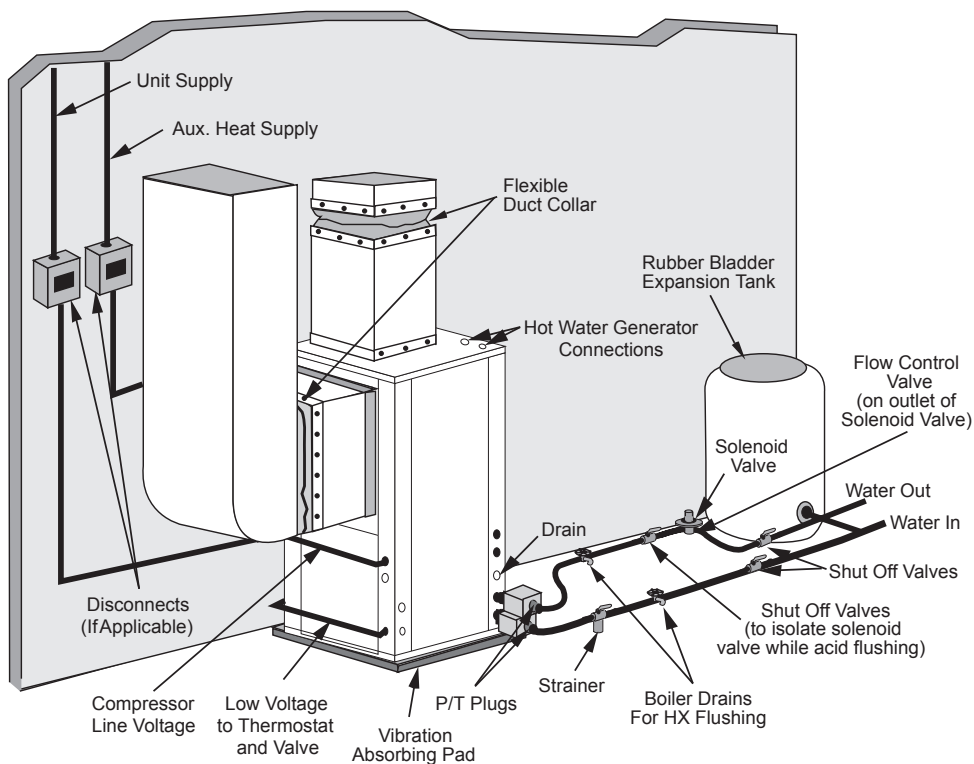

## Freeze Detection

For Aurora Base Control, set SW2-1, FP1, on the printed circuit board for applications using a closed loop antifreeze solution to 15°F [-9.4°C]. On applications using an open loop/ground water system (or closed loop no antifreeze), set this dip switch to 30°F [-1.1°C], the factory default setting. (Refer to the Dip Switch Field Selection table).

## Reference Calculations

Heating Calculations:	Cooling Calculations:
$\text{LWT} = \text{EWT} - \frac{\text{HE}}{\text{gpm} \times 500}$	$\text{LWT} = \text{EWT} + \frac{\text{HR}}{\text{gpm} \times 500}$
$\text{LAT} = \text{EAT} + \frac{\text{HC}}{\text{cfm} \times 1.08}$	$\text{LAT(DB)} = \text{EAT(DB)} - \frac{\text{SC}}{\text{cfm} \times 1.08}$
$\text{TH} = \text{HC} + \text{HWC}$	$\text{LC} = \text{TC} - \text{SC}$
	$\text{S/T} = \frac{\text{SC}}{\text{TC}}$

## Legend and Notes

cfm = airflow, cubic feet/minute  
 EWT = entering water temperature, Fahrenheit  
 gpm = water flow in gallons/minute  
 WPD = water pressure drop, psi and feet of water  
 EAT = entering air temperature, Fahrenheit  
 (dry bulb/wet bulb)  
 HC = air heating capacity, MBtu/h  
 TC = total cooling capacity, MBtu/h  
 SC = sensible cooling capacity, MBtu/h  
 kW = total power unit input, kilowatts  
 HR = total heat of rejection, MBtu/h

HE = total heat of extraction, MBtu/h  
 HWC = hot water generator capacity, MBtu/h  
 EER = Energy Efficient Ratio  
 = BTU output/Watt input  
 COP = Coefficient of Performance  
 = Btu output/Btu input  
 LWT = leaving water temperature, °F  
 LAT = leaving air temperature, °F  
 TH = total heating capacity, MBtu/h  
 LC = latent cooling capacity, MBtu/h  
 S/T = sensible to total cooling ratio

### Notes (Refer to Performance Data tables)

- Performance ratings are based on 80°F DB / 67°F WB EAT for cooling and 70°F DB EAT for heating.
- Three flow rates are shown for each unit. The lowest flow rate shown is used for geothermal open loop/well water systems with a minimum of 50°F EWT. The middle flow rate shown is the minimum geothermal closed loop flow rate. The highest flow rate shown is optimum for geothermal closed loop systems and the suggested flow rate for boiler/tower applications.
- Entering water temperatures below 40°F assumes 15% antifreeze solution.
- For non-standard EAT conditions, apply the appropriate correction factors on (Refer to Correction Factor Tables).
- Interpolation between EWT, gpm, and cfm data is permissible.

## Compressor and Thermistor Resistance

### Compressor Resistance Chart

Model		Connections	208-230/60/3			460/60/3			575/60/3		
Dual Capacity	084	T1-T2 T2-T3 T3-T1	0.486	0.486	0.486	2.508	2.046	2.046	3.575	3.575	3.575
	096	T1-T2 T2-T3 T3-T1	0.486	0.486	0.486	2.268	1.851	1.851	3.575	3.575	3.575
	120	T1-T2 T2-T3 T3-T1	0.329	0.329	0.329	1.704	1.38	1.38	2.327	2.327	2.327
Two Compressor	150	T1-T2 T2-T3 T3-T1	0.542	0.542	0.542	2.161	2.161	2.161	4.91	3.75	4.91
	180	T1-T2 T2-T3 T3-T1	0.486	0.486	0.486	2.096	1.697	1.697	2.763	2.763	2.763
	240	T1-T2 T2-T3 T3-T1	0.329	0.329	0.329	1.704	1.38	1.38	2.327	2.327	2.327
	300	T1-T2 T2-T3 T3-T1	0.265	0.265	0.265	1.044	1.044	1.044	1.688	1.688	1.688
	360	T1-T2 T2-T3 T3-T1	0.2	0.2	0.2	0.83	0.83	0.83	1.32	1.32	1.32

2/19/25

### Thermistor Resistance Chart

Thermistor Resistance (10k Ohm) for FP1, FP2, HWL, LWT, LLT, and EWT	
Temperature (°F)	Resistance (Ohms)
5	75757-70117
14	57392-53234
23	43865-40771
32	33809-31487
41	26269-24513
50	20570-19230
59	16226-15196
68	12889-12093
77	10310-9688
86	8300-7812
95	6723-6337
104	5480-5172
113	4490-4246
122	3700-3504
131	3067-2907
140	2554-2424
149	2149-2019

1/21/21

## Troubleshooting Checklist

### Equipment will not start or operate

- Follow the troubleshooting flow charts to find root cause.

### High pressure lockout in the heating mode

- Check for air flow interruption from one or more of the following: inoperative blower, dirty filters or air coil, blocked return air grill, closed or blocked supply registers, restricted supply or return duct, zone dampers, etc. If airflow is suspected as being a problem, make a quick check using the following example: Velocity in a supply duct should not exceed 1000 fpm and 700 fpm in return ducts. For this example we will use an model 038 which has a maximum rating of 1500 cfm at 0.50 static (Refer to the blower performance tables in the install manual for your particular piece of equipment). Using the formula: Area in square feet equals quantity in cfm divided by velocity in fpm ( $A=cfm/fpm$ ), 1.57 sq. ft. is needed for the supply duct and 2.14 sq. ft. is needed for the return duct. Refer to the troubleshooting flow charts if a problem with the blower motor or logic board is suspected.
- Check for blocked or seized expansion valve assembly.
- Make sure the discharge pressure is within the operating range shown in the product install manual.
- The unit may be overcharged; check superheat and sub cooling. If this problem is verified, recharge using approved methods.

### High pressure lockout in the cooling mode

- Water flow may be restricted or inadequate. Verify in accordance with the pressure drop tables shown in product install manual. Also, look for the following: solenoid valve may not be opening on well water units, pump(s) may be inoperative in the flow center, debris may be blocking coil (back flush using at least 20 PSI), or air may be in the loop (flush loop).
- Water to refrigerant heat exchanger may be fouled with debris. If so, back flush with at least 20 psi of water pressure.
- If mineral accumulation is evident, clean the heat exchanger with acid.
- Entering air temperature may be too high. Equipment is designed for a maximum of 85°F DB and 71°F WB.
- Check for a seized or blocked expansion valve assembly.
- The unit may be overcharged; check superheat and sub cooling. If this problem is verified, recharge using approved methods.

### Low pressure lockout in heating mode

- If equipment is installed in a low temperature area (below 50°F), install a crankcase heater, then protect the unit from the elements.
- Water flow may be restricted or inadequate. Verify in accordance with the pressure drop tables shown in product install manual. Also, look for the following: solenoid valve may not be opening on well water units, pump(s) may be inoperative in the flow center, debris may be blocking coil (back flush using at least 20 PSI), or air may be in the loop (flush loop).
- Check for a seized or blocked expansion valve assembly.

- Return air temperature may be below 50°F. Block off air coil temporarily to improve flow of refrigerant through the system. Air below 50°F cannot be tolerated on a continuing basis. Correct the problem.
- Refrigerant may be low. Check for leaks, reclaim refrigerant, repair if necessary, recharge using approved methods.

### Low pressure lockout in the cooling mode

- Check for inadequate air flow. Follow the same procedure as shown for a high pressure lockout in the heating mode.
- Check for a seized or blocked expansion valve assembly.
- Refrigerant charge may be low.

### Water flow lockout in either the heating or cooling mode

- Water flow may be restricted or inadequate. Verify in accordance with the pressure drop tables shown in product install manual. Also, look for the following: solenoid valve may not be opening on well water units, pump(s) may be inoperative in the flow center, debris may be blocking coil (back flush using at least 20 PSI), or air may be in the loop (flush loop).
- Disconnect freeze sensor from control and measure the resistance. Cross reference with the Thermistor Data table.

### Condensate over flow lockout in either the heating or cooling mode

- Make sure the drain line pitches away from the unit. Install a vertical vent on horizontal drain lines over six feet long. Clean condensate pan and be sure outlet and drain line from the condensate pan is clear.

### Reversing valve does not operate

- Disconnect solenoid and check for continuity across coil. Replace coil if continuity is not found.
- If stuck reversing valve is suspected, restrict airflow in heating mode (to build pressure), then switch immediately to the cooling mode.

## Control Board Troubleshooting Steps

### 1) General Check

- If any new device was installed, or any wiring was changed, check the connections to ensure the wiring is correct, and all the wires are in good condition.
- Verify all the plugs are securely connected and in good condition.
- Check the DIP switch (SW2) positions are correct.
- Measure 24 VAC between R and C. (The actual reading may be from 18 to 30 VAC). Check the incoming power and the power transformer if the R and C voltage reading is not correct.

### 2) No LEDs are On

- Check 24 VAC on board.
- Check the 3 amp fuse. Replace the fuse if needed.
- Verify transformer circuit breaker has not tripped if no low voltage is present.
- Disconnect the thermostat connection P1.
- Replace the Aurora base control board.

### 3) Red LED Flash Code

**Input Fault (Code 1)** – Indicates that both O and W input signals are present. Disconnect the thermostat connector from the ABC board and then cycle power to the board. If the fault does not reappear, then the problem is between the thermostat and the thermostat connector. Otherwise, replace the ABC board.

**High Pressure Fault (Code 2)** – Indicates the system pressure has exceeded 600 psi (R-410A) which may have been caused by low water flow in cooling, (check coaxial heat exchanger for mineral build-up) or low air flow in heating (check filters and coil for dirt build-up). Measure P4-9 and C is 24 VAC. If not, replace ABC. Check the heat pump refrigeration system. Cycle the power to reset the system. Measure P4-10 and C is 24 VAC. If not, replace the high pressure sensor.

**Low Pressure Fault (Code 3)** – Indicates low pressure switch has opened which may indicate a loss of system charge, system restriction, or frozen heat exchanger. Measure P4-7 and C is 24 VAC. If not, replace ABC. Check the heat pump refrigeration system. Cycle the power to reset the system. Measure P4-8 and C is 24 VAC. If not, replace the low pressure sensor. Refrigerant may be low. Check for leaks, reclaim refrigerant, repair if necessary, pump down and recharge the system to the quantity of refrigerant shown on the unit nameplate.

**Freeze Detection 1 Fault (Code 5)** – Indicates low or no water flow; low system charge; or faulty TXV in heating mode. Make sure the DIP switch FP1 (SW2-1) selection matches the application. Measure the temperature on the refrigerant line next to the freeze detection thermistor. Disconnect the connector P4. Measure the resistance reading between P4-3, P4-4. Refer to the Thermistor Data table, find the corresponding temperature data. Compare the data with the temperature measurement from the refrigerant line. The temperature should be within +/- 2° F. If not, replace the thermistor.

Other items to check when troubleshooting a water flow lockout are superheat, water flow through the coaxial heat exchanger and antifreeze composition. High superheat in heating will lower the refrigerant line temperature where the freeze detection thermistor is located. In this case, check the TXV. Closed loop systems are rated at 3 gpm/ton. If a closed loop system is running at less than 3 gpm/ton, the temperature difference between the refrigerant line and the actual leaving water temperature will be greater and could lead to possible water flow lockouts.

**Condensate Fault (Code 7)** – Indicates condensate water in the drain pan fills up and touches the spade terminal. Make sure the drain line pitches away from the unit. Install a vertical vent on horizontal drain lines over six feet long. Clean and be sure outlet and drain line from the condensate pan is clear. Jumper between R, Y2 and O to start 2nd stage cooling. Observe the water level in the drain pan. If the unit is locking out on condensate and the drain pan is dry, remove the condensate wire from the drain pan and tape it out of the way. Be careful to not ground the wire out because that will cause the unit to lockout on drain overflow. If the unit is still locking out, check the brown wire all the way back to the ABC for a short to ground. Remember that the condensate sensor is just a wire looking for a ground. If it touches any metal in the cabinet, the unit will see that as a drain fault. If removing the wire from the drain pan stopped the false drain lockouts, put the condensate sensor back in place in the drain pan. Pay close attention to how far the spade terminal sits down in the drain pan. If the terminal is pushed all the way down so that it is touching the bottom of the drain pan, this will cause a drain lockout if there is any trace of water. If the spade terminal fits loosely in the drain pan, spread the terminal open to make it fit snugly in the drain pan.

**Over/Under Voltage Shutdown Fault (Code 8)** – Indicates the control voltage is or had been outside the range of 18 to 30 VAC for more than 15 minutes. Using a voltage meter, check the incoming power line voltage is within + or – 25%. If not, there is a power line issue. Check the secondary of the control transformer with a voltage meter. The voltage should be 18 to 30 VAC. If not, replace the control transformer.

**Freeze Detection FP1 Sensor Fault (Code 11)** – Indicates the freeze detection sensor is out of range. Disconnect the connector P4. Measure the resistance reading between P4-3, P4-4. Refer to the Thermistor Data table, find the corresponding temperature data. Compare the data with the temperature measurement from the refrigerant line. The temperature should be within +/- 2° F. If not, replace the thermistor.

## Control Board Troubleshooting Steps cont.

### 4) Other Faults

#### **ECM Motor Will Not Start**

1. Measure the voltage output between P13-1 and P13-5. Reference the chart below for blower speed vs. voltage.

Blower Speed Selection Number	DC Volts
1	0.6 VDC
2	2.7 VDC
3	4.6 VDC
4	7.5 VDC
5	9.8 VDC
6	12.5 VDC
7	14.4 VDC
8	16.3 VDC
9	18.5 VDC
10	21.2 VDC
11	22.3 VDC
12	23.4 VDC

2. Measure the voltage from C to F terminals (P5-2). The reading should be 24VAC.

**Compressor First Stage Will Not Start** – Measure the voltage output between P5-4 and P5-5, P5-7 and P5-8. The reading should be 24 VAC. If 24 VAC is not present check transformer output, thermostat wiring, current fault status, etc.

**Compressor Second Stage Will Not Start** – Measure the voltage output between P5-6 and P5-8. The reading should be 24 VAC. If 24 VAC is not present, check DIP switch settings, thermostat operation, and thermostat wiring.

**PSC Motor Will Not Start** – Measure the voltage output between P5-2 and P5-3. The reading should be 24 VAC.

**No Alarm Output** – Measure the voltage output between P2-4 and C. The reading should be 24 VAC or a pulsed 24 VAC dependent on the selection of SW2-7. If SW2-8 is set for reheat, the alarm output will be used to control the hot gas reheat valve and will not show lockout information.

**Accessory Relay Does Not Operate** – Measure the continuity between P2-2 and P2-3. It should read closed when relay is engaged. If this is not correct, check SW2-4 and SW2-5 settings.

**No Lockout Output** – Measure the voltage output between P1-1 and C. The reading should be 24 VDC or a pulsed 24 VDC dependent on the selection of SW2-7. If voltage is not present, make sure the unit is in lockout and not fault retry.

**Auxiliary Heater Does Not Function** – Measure the voltage output between P3-1, P3-2, and P3-3, P3-4. The output should be 24 VDC. If voltage is not present, check thermostat operation and wiring.

**Loop Pump Does Not Start** – The loop pump is controlled by the AXB board. Check to make sure the control board is powered by taking a voltage reading across R and C to check for 24VAC. If 24VAC is not present check the wiring connections, 24VAC is supplied to the AXB through the harness connected to P9. Next check to make sure the ABC is attempting to run the compressor, the loop pump will only run when the ABC is commanding CC on, the pump slave input is active, or the AXB has lost communication with the ABC. Please refer to troubleshooting flow charts for additional checks on the loop pump.

### 5) Operation Modes

**Enter First Stage Heating** – Remove P1. Place a jumper between R and Y1.

**Enter Second Stage Heating** – Remove P1. Place a jumper between R, Y1 and Y2. This is for SW2-6 set to “OFF” position.

**Enter Third Stage Heating** – Remove P1. Place a jumper between R, Y1, Y2 and W.

**Enter First Stage Cooling** – Remove P1. Place a jumper between R, O and Y1.

**Enter Second Stage Cooling** – Remove P1. Place a jumper between R, O, Y1 and Y2.

**Enter Emergency Heating** – Remove P1. Place a jumper between R and W.

**Enter Blower Only Mode** – Remove P1. Place a jumper between R and G.

**Enter Reheat Mode** – Remove P1. Place a jumper between R and DH. (SW2-8 must be off)

These notes are for SW2-3 set to “ON” position.

# Control Board Troubleshooting Flow Charts

Use the following flow charts to aid in troubleshooting the control board.

## Compressor Will Not Start Without AID Tool

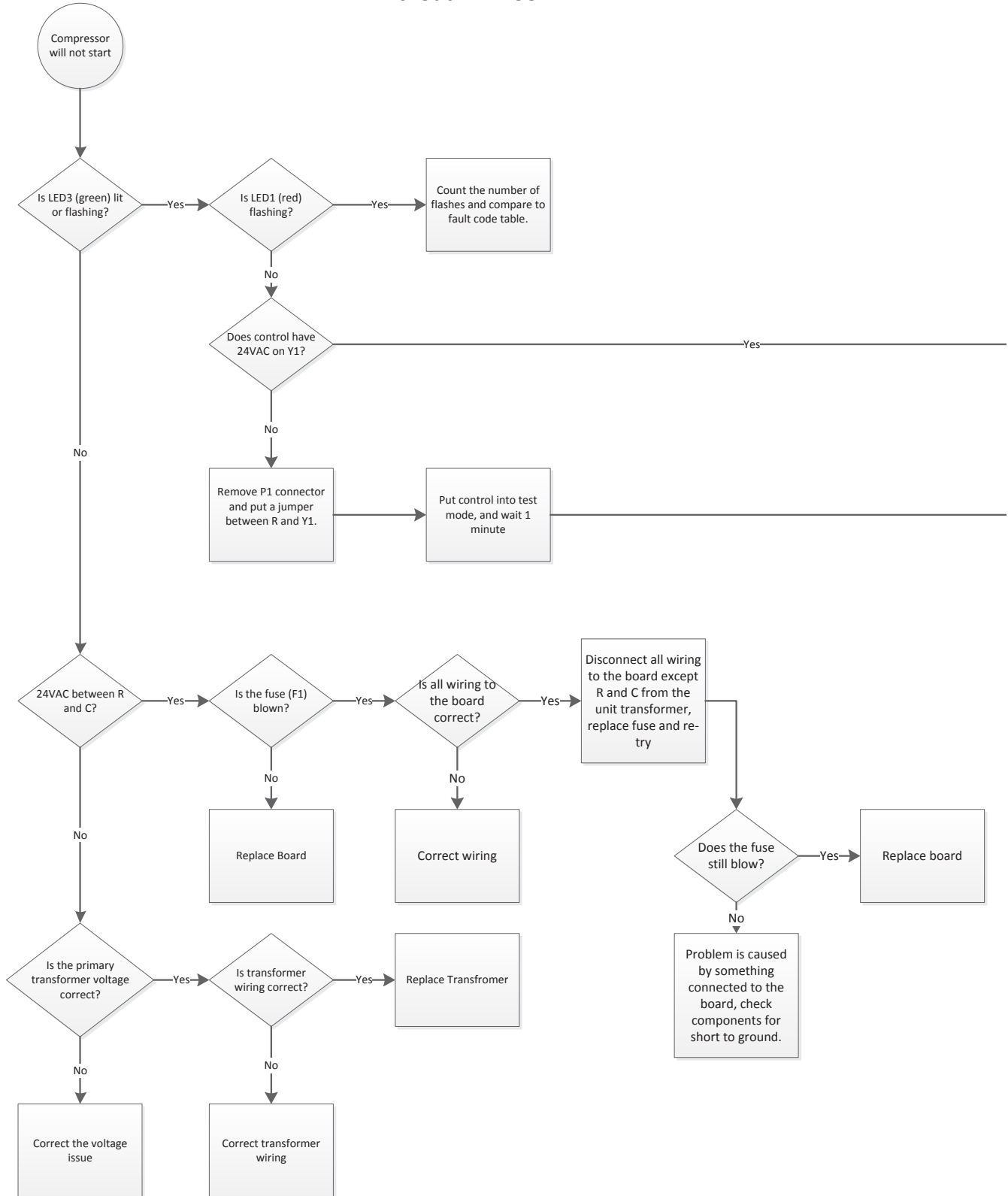



# Control Board Troubleshooting Flow Charts cont.

**Notes:**

1. When measuring 24VAC actual value may be between 18 and 30VAC.

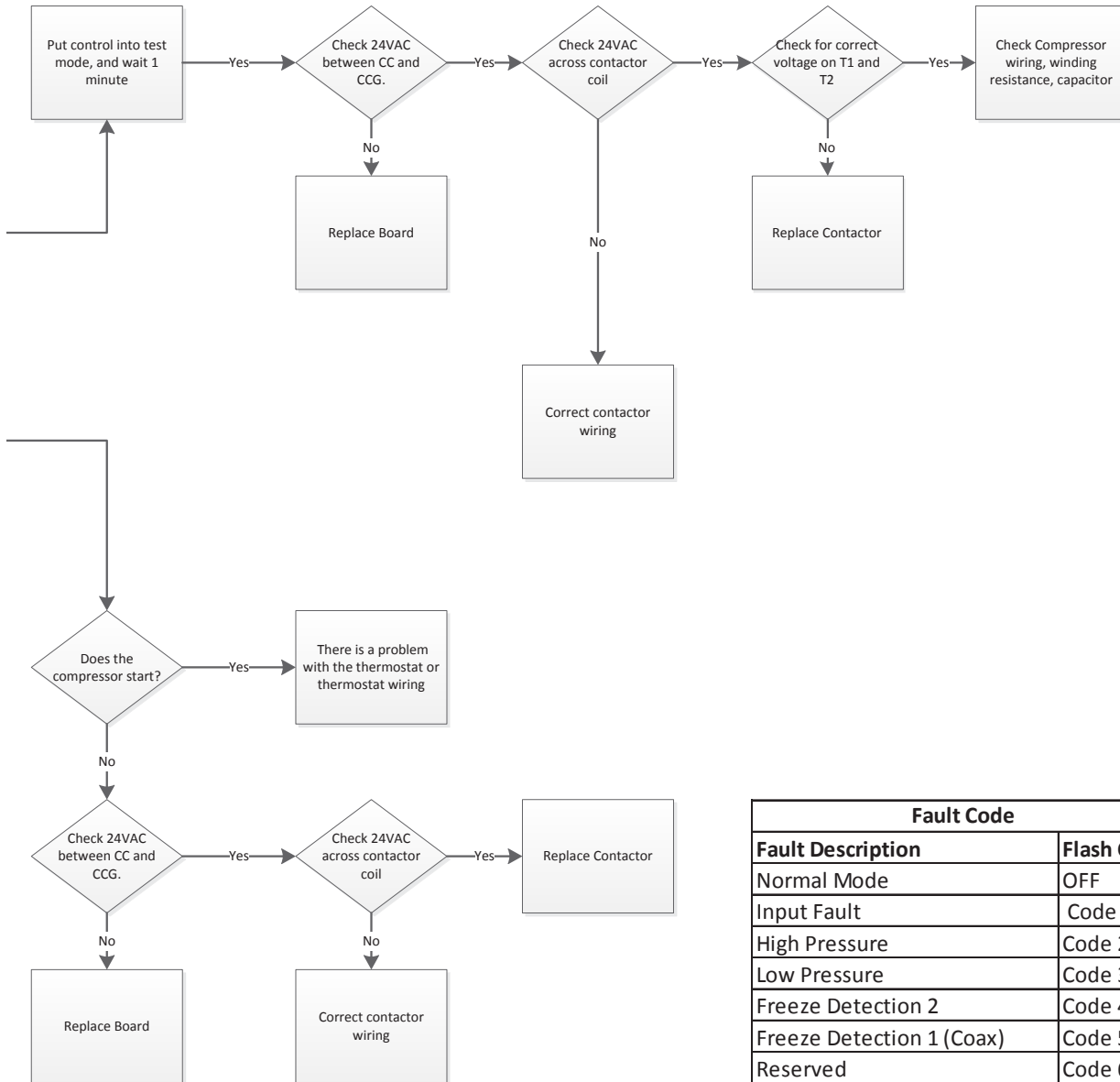

Fault Code	
Fault Description	Flash Code
Normal Mode	OFF
Input Fault	Code 1
High Pressure	Code 2
Low Pressure	Code 3
Freeze Detection 2	Code 4
Freeze Detection 1 (Coax)	Code 5
Reserved	Code 6
Condensate	Code 7
Over/Under Voltage	Code 8
Not Used	Code 9
Freeze Detection Sensor Error	Code 11

**NOTE:** Refer to the Control Board Troubleshooting Steps for fault descriptions.

# Control Board Troubleshooting Flow Charts cont.

## Compressor Will Not Start With AID Tool

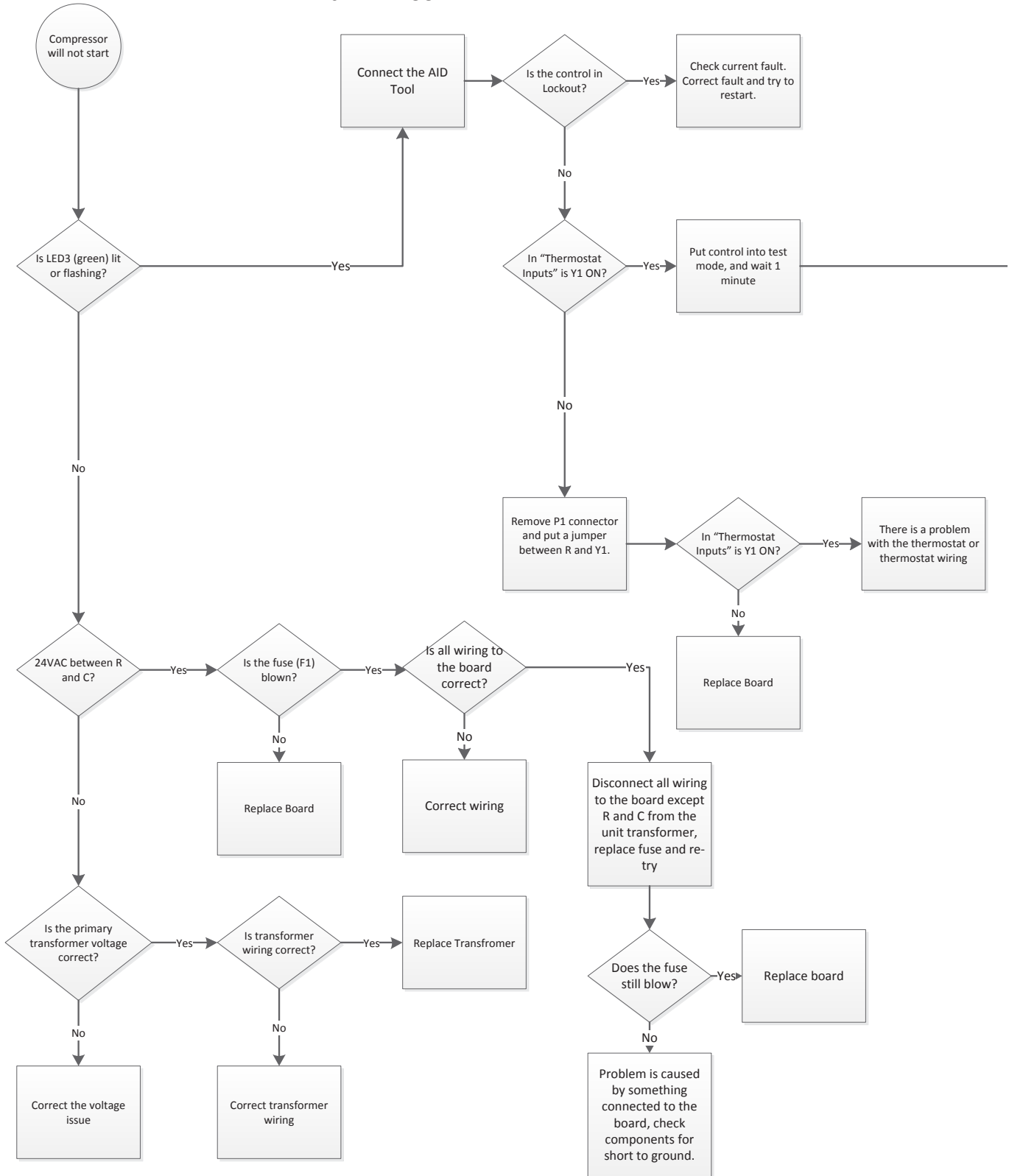

## Control Board Troubleshooting Flow Charts cont.

**Notes:**

1. When measuring 24VAC actual value may be between 18 and 30VAC.

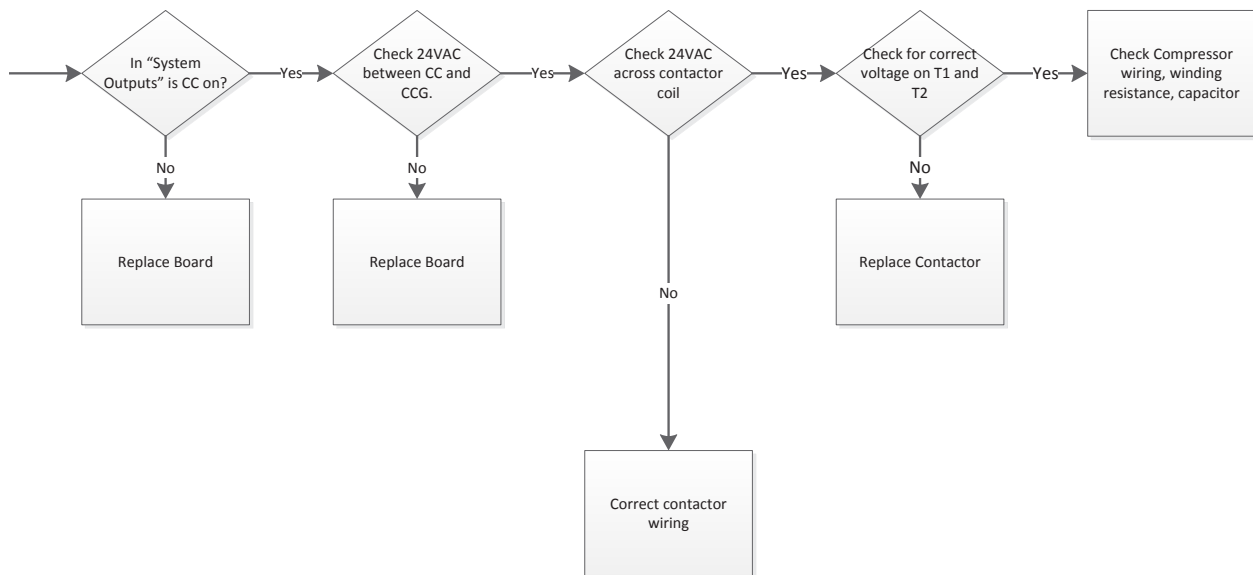

# Control Board Troubleshooting Flow Charts cont.

## ECM Blower Will Not Start Without AID Tool

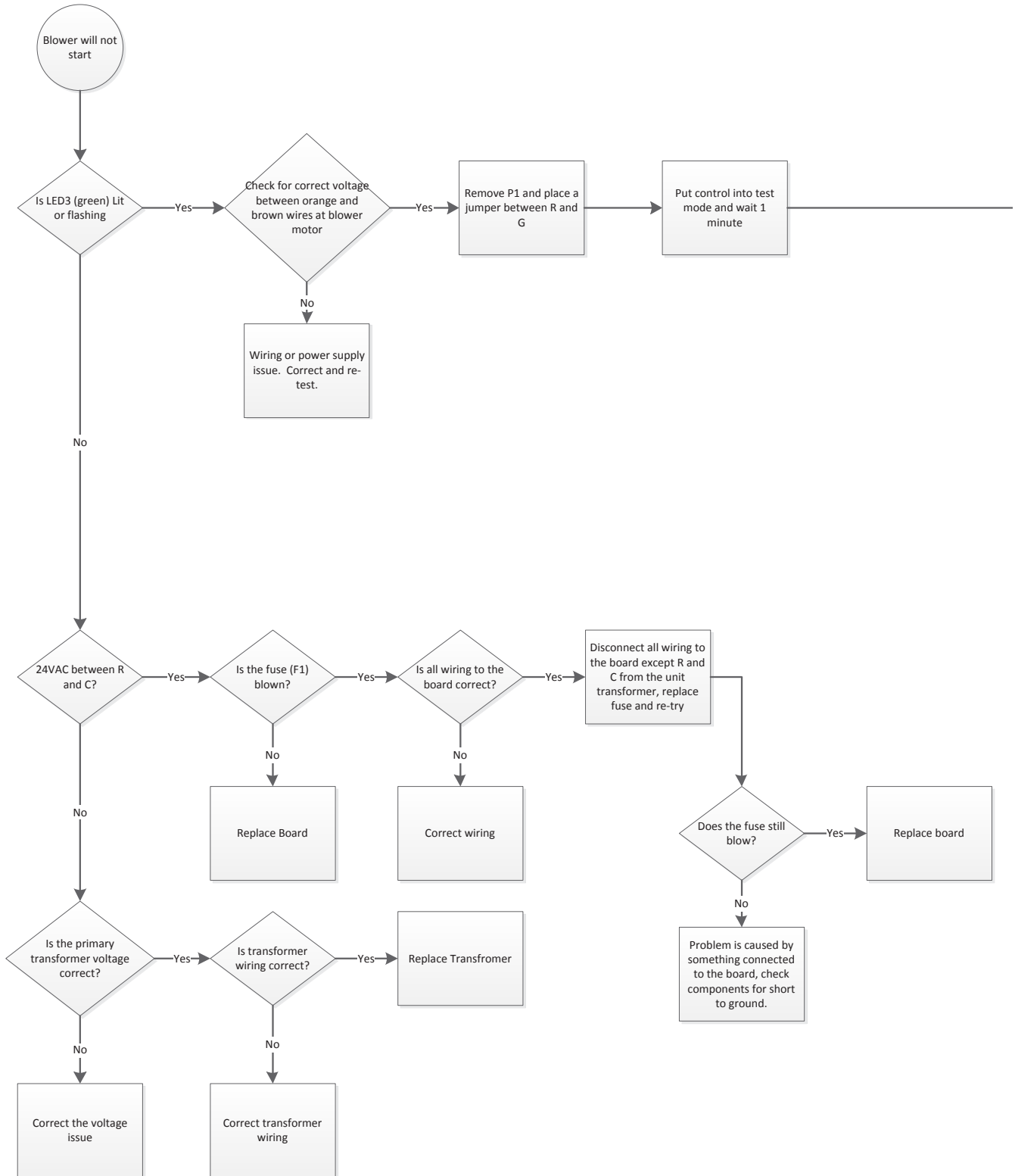

# Control Board Troubleshooting Flow Charts cont.

**Notes:**

1. When measuring 24VAC actual value may be between 18 and 30VAC.

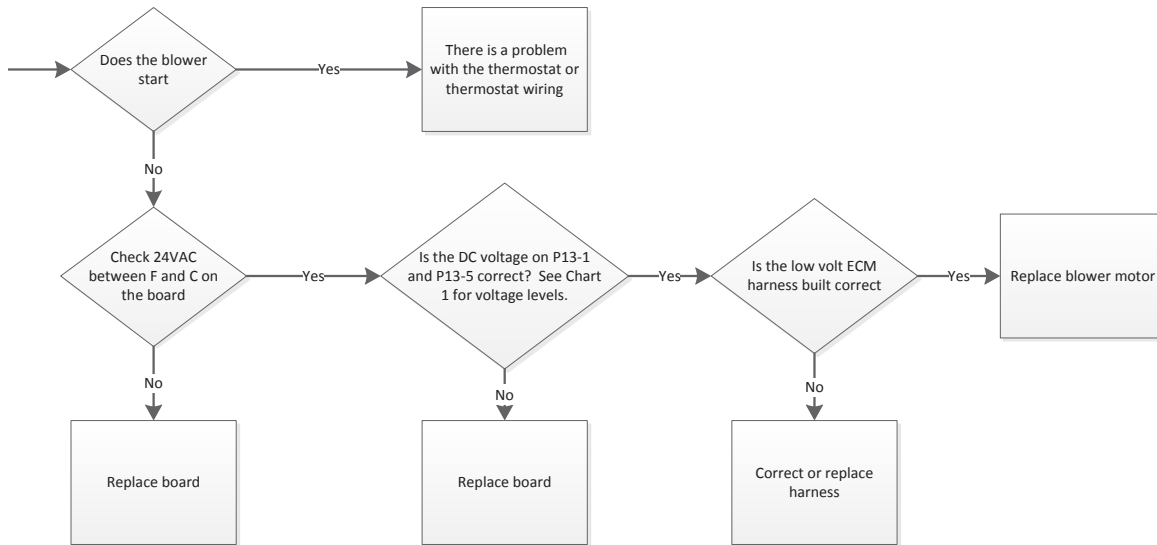

Chart 1

Blower Speed Selection Number	DC Volts
1	0.6VDC
2	2.7VDC
3	4.6VDC
4	7.5VDC
5	9.8VDC
6	12.5VDC
7	14.4VDC
8	16.3VDC
9	18.5VDC
10	21.2VDC
11	22.3VDC
12	23.4VDC

# Control Board Troubleshooting Flow Charts cont.

## ECM Blower Will Not Start With AID Tool



# Control Board Troubleshooting Flow Charts cont.

**Notes:**

1. When measuring 24VAC actual value may be between 18 and 30VAC.

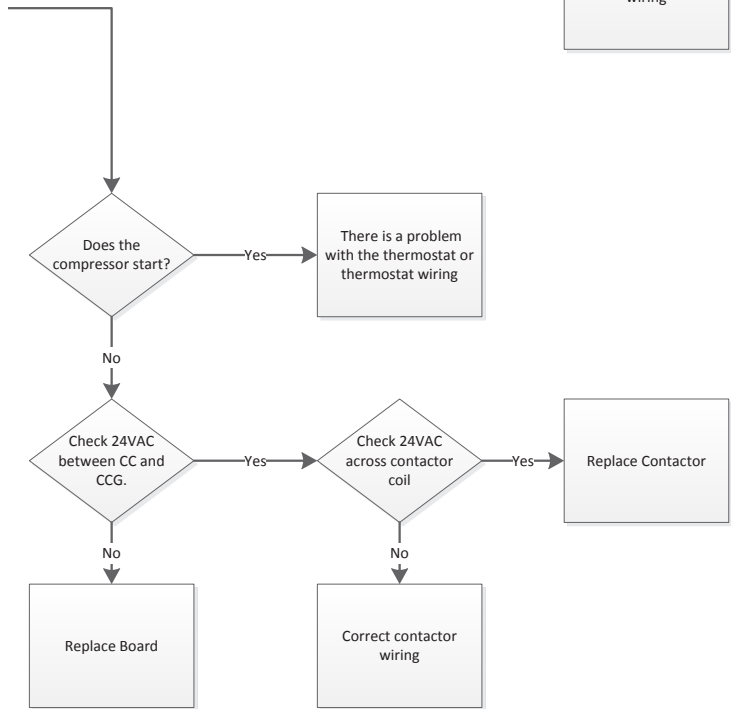
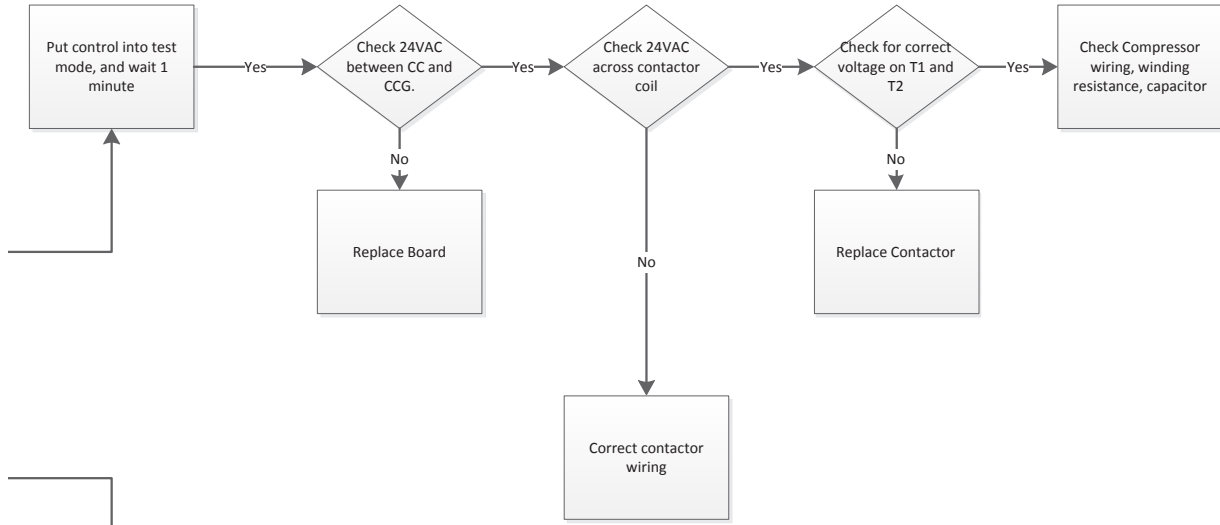

Fault Code	
Fault Description	Flash Code
Normal Mode	OFF
Input Fault	Code 1
High Pressure	Code 2
Low Pressure	Code 3
Freeze Detection 2	Code 4
Freeze Detection 1 (Coax)	Code 5
Reserved	Code 6
Condensate	Code 7
Over/Under Voltage	Code 8
Not Used	Code 9
Freeze Detection Sensor Error	Code 11

# Control Board Troubleshooting Flow Charts cont.

## Loop Pump Will Not Start Variable Speed Pump

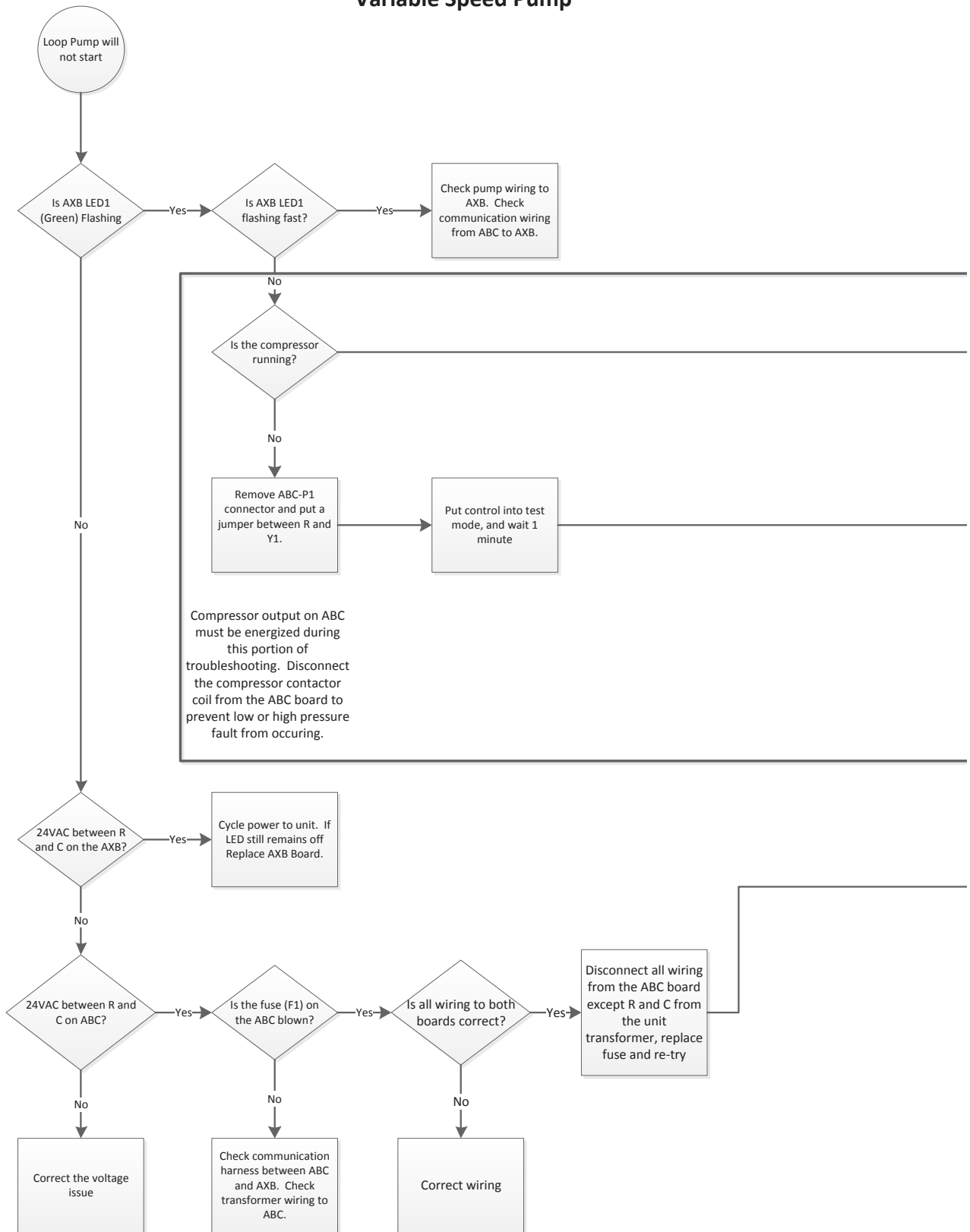



## Control Board Troubleshooting Flow Charts cont.

**Notes:**

1. When measuring 24VAC actual value may be between 18 and 30VAC.
2. When measuring 240VAC actual value may be between 190 and 250 VAC.

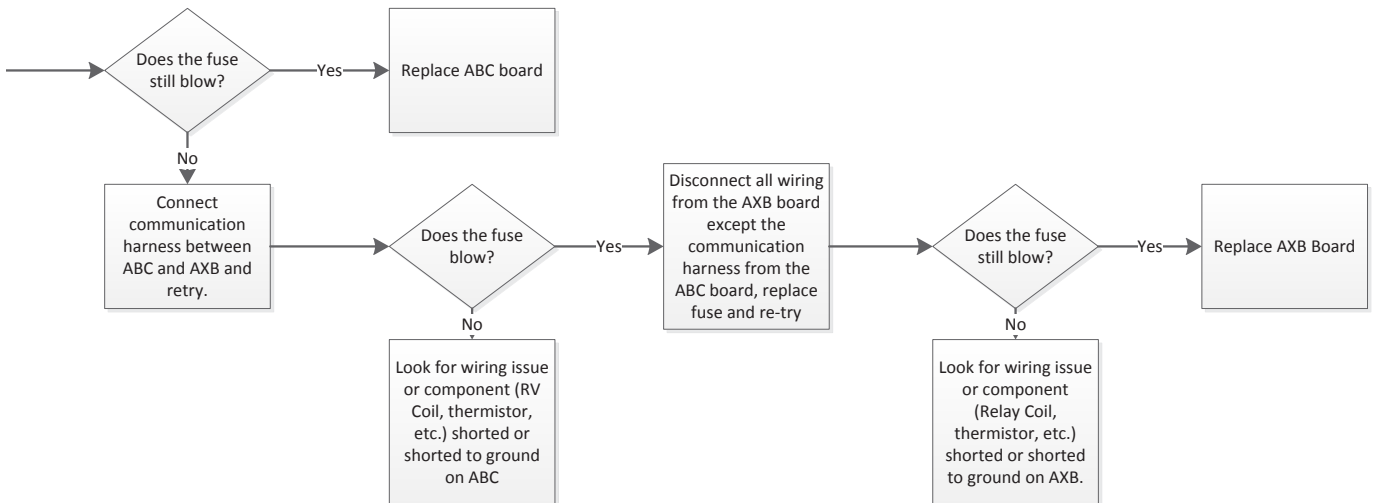
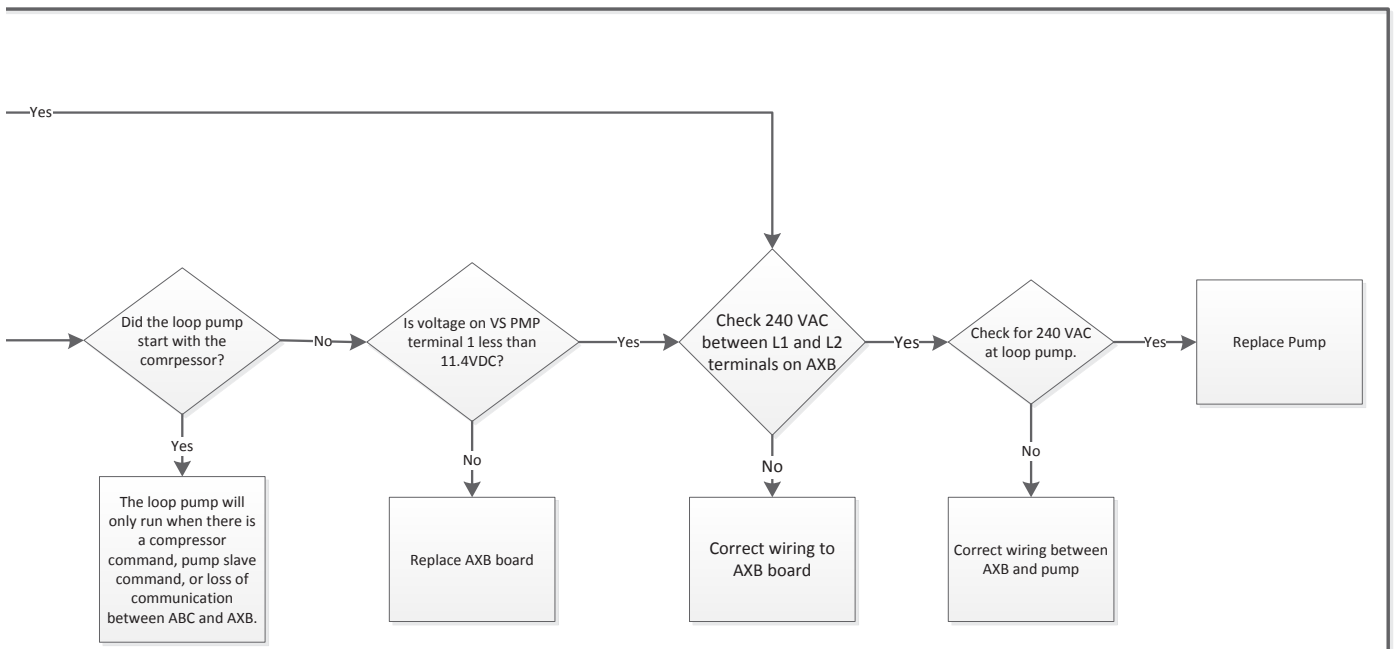

# Control Board Troubleshooting Flow Charts cont.

## Loop Pump Will Not Start Non Variable Speed Pump

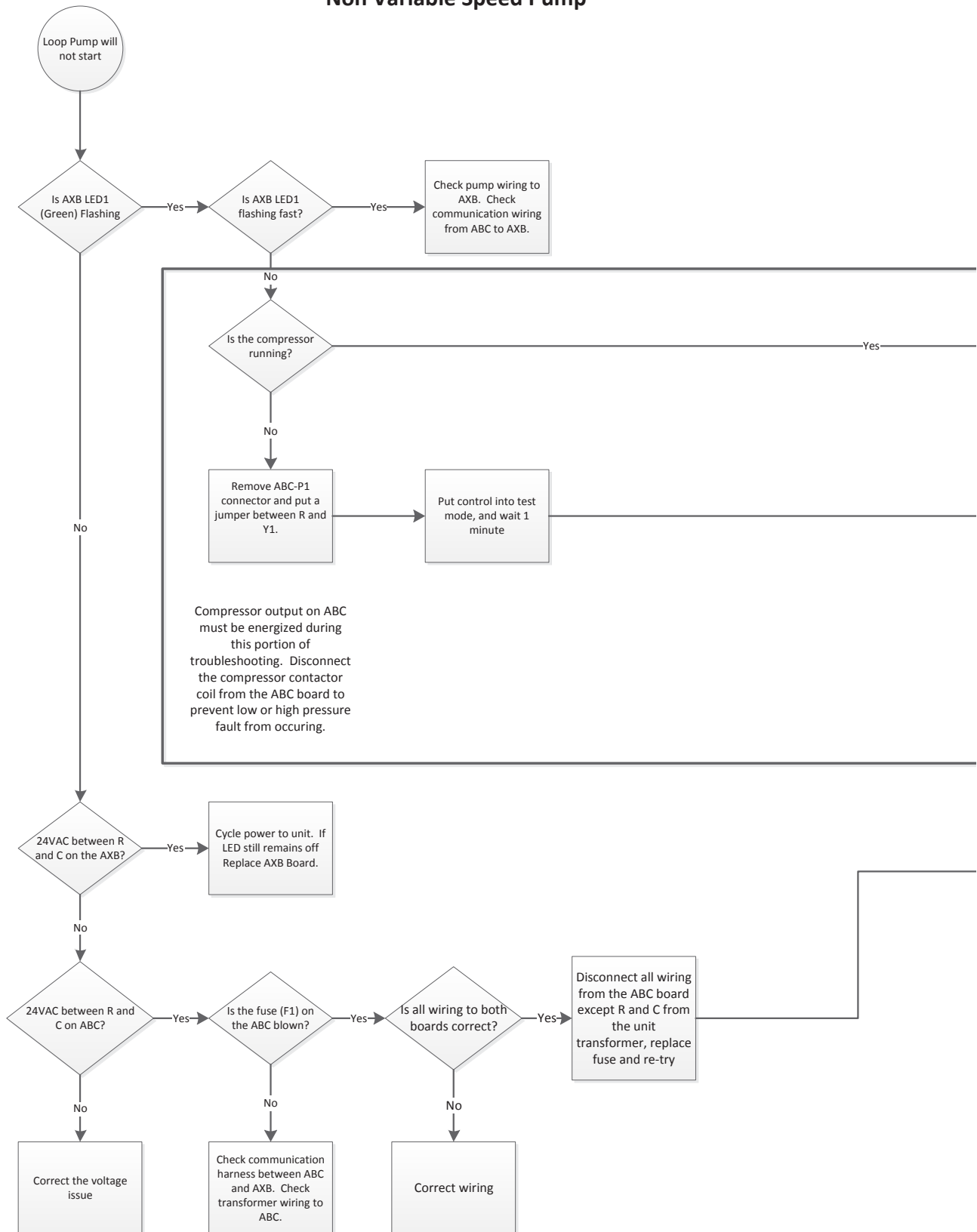

# Control Board Troubleshooting Flow Charts cont.

**Notes:**

1. When measuring 24VAC actual value may be between 18 and 30VAC.
2. When measuring 240VAC actual value may be between 190 and 250 VAC.

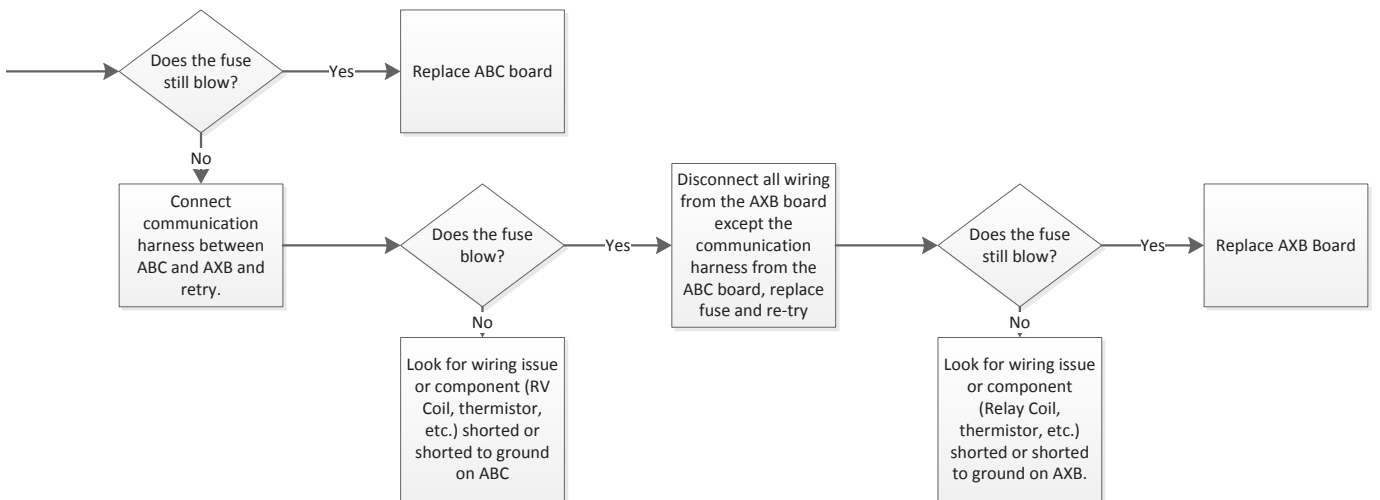
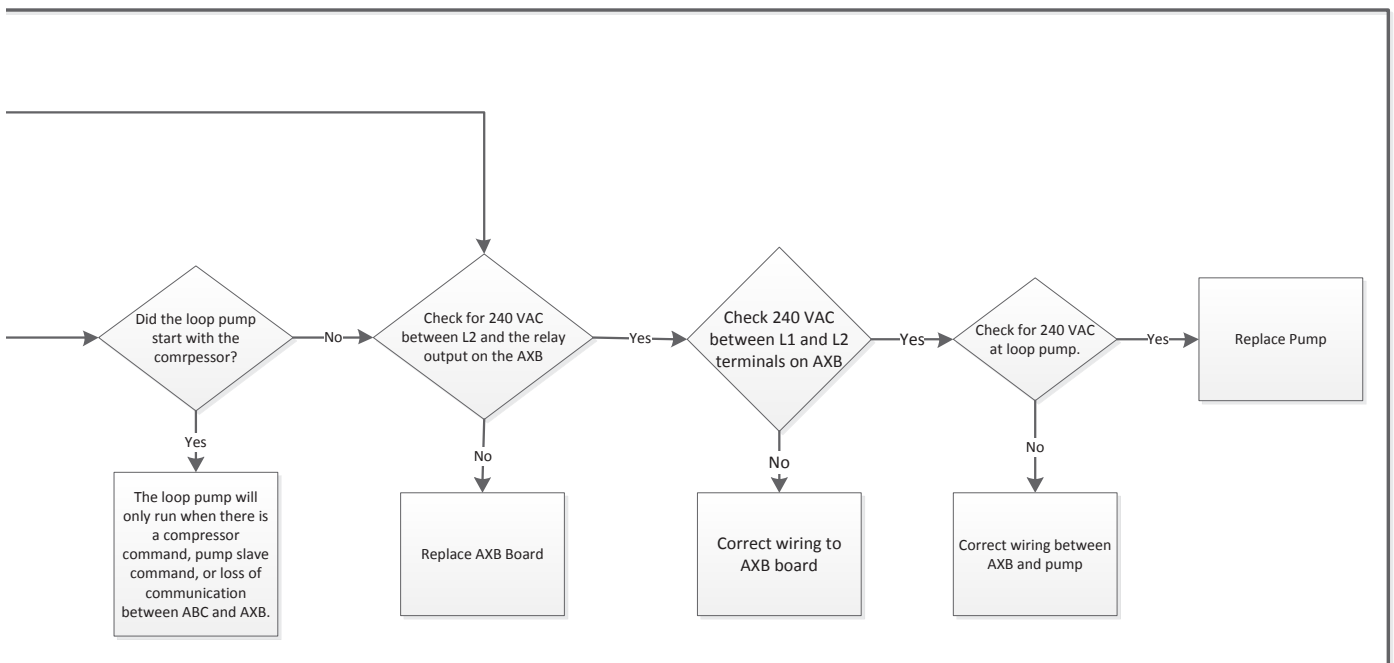

# Communicating Thermostat Troubleshooting Guide

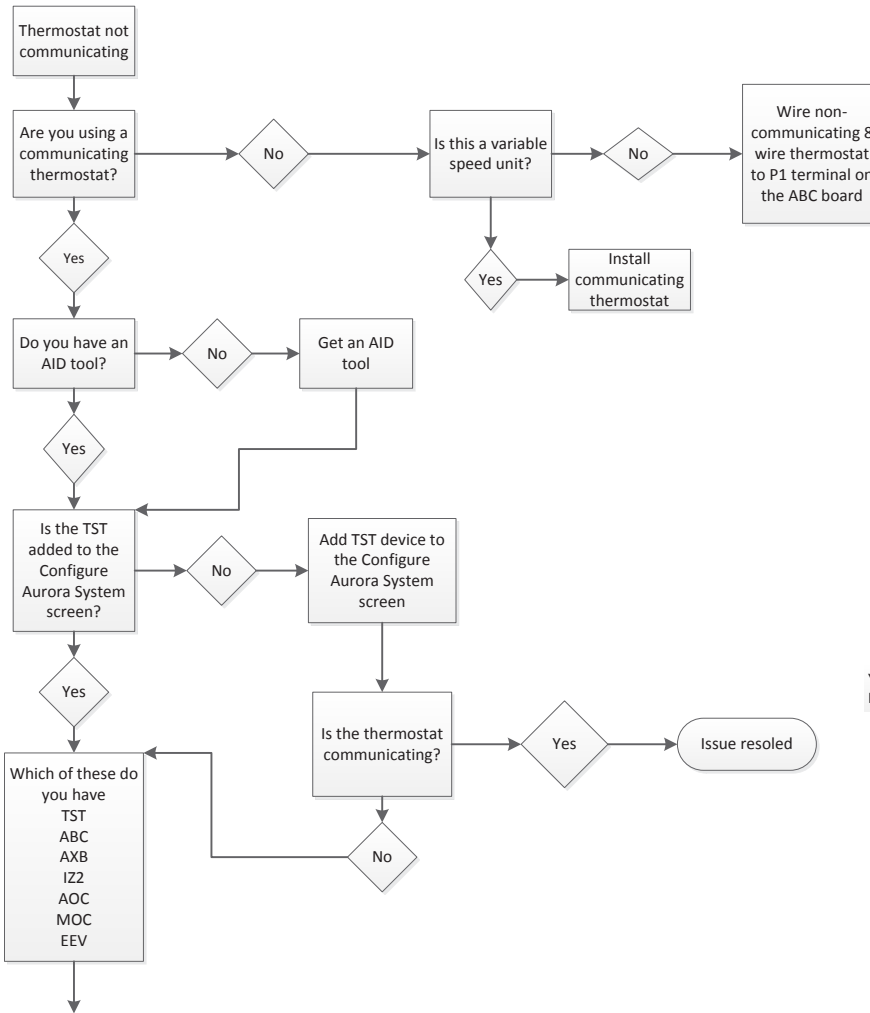

Continue to Next Page

Configure Aurora System Screen

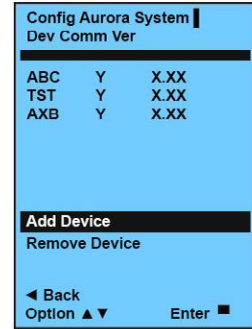

Single and Dual Capacity unit

Y – Active Communication  
 N – Device has been found, but communication has failed.

# Communicating Thermostat Troubleshooting Guide cont.

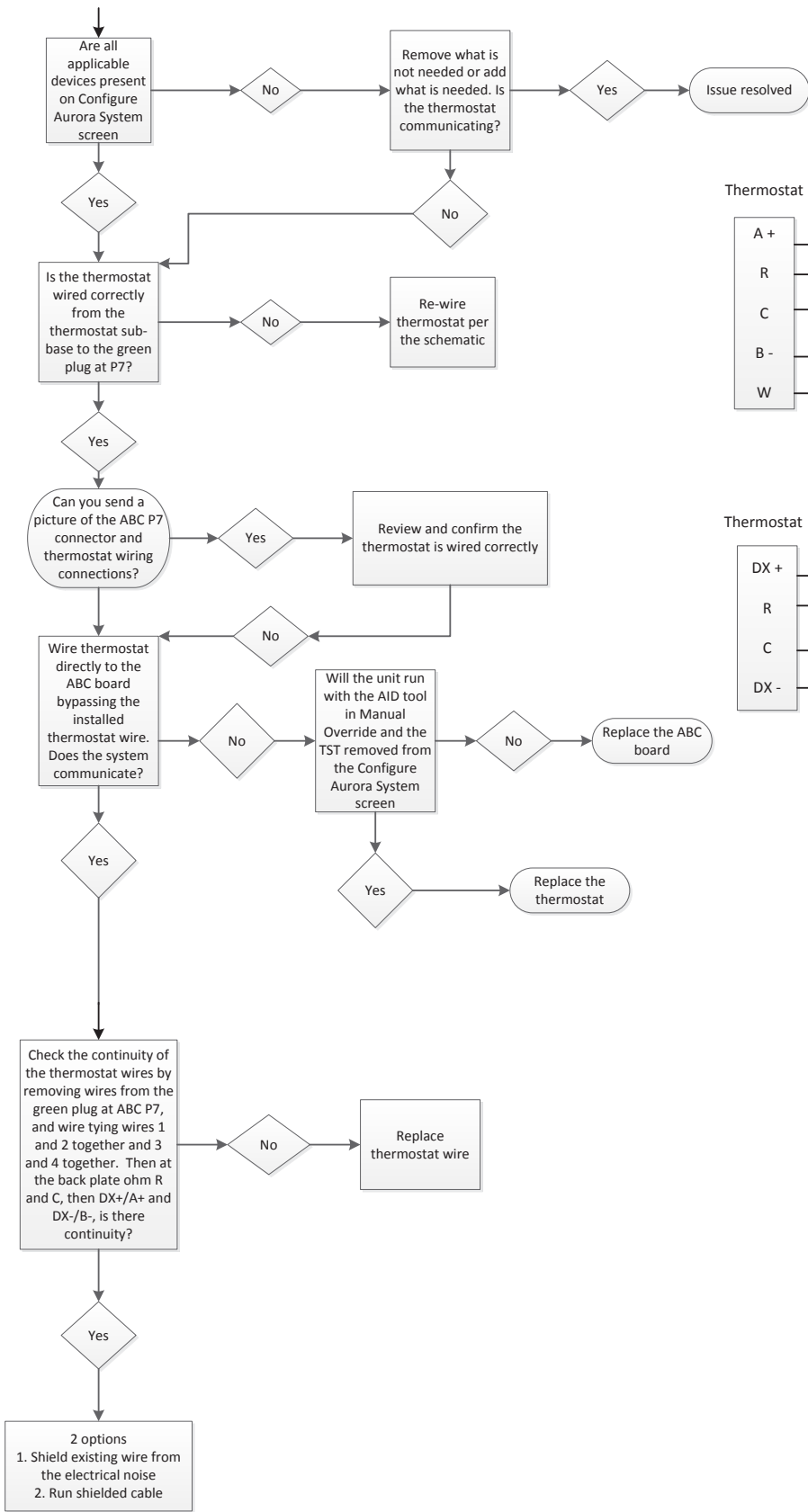

**TPCM32U03A /TPCM32U04A**

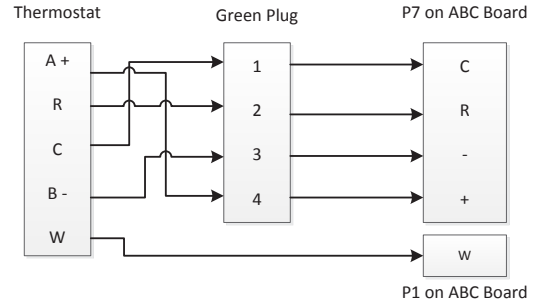

**TPCC32U01**

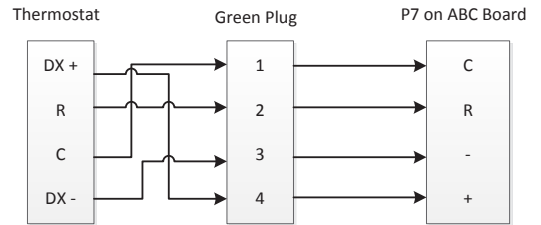

## Control Board Signals

### To Check for 24VAC between R and C

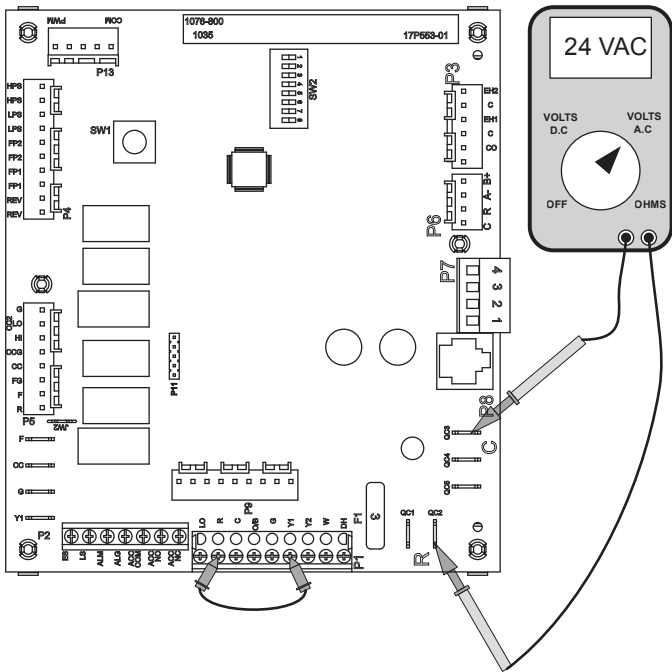

With power applied to the unit connect your Volt meter leads to “R” and “C” on the control board where the yellow and black/white transformer wires connect. The reading should be between 18VAC and 30VAC.

### To Check for 24VAC to Compressor Contactor

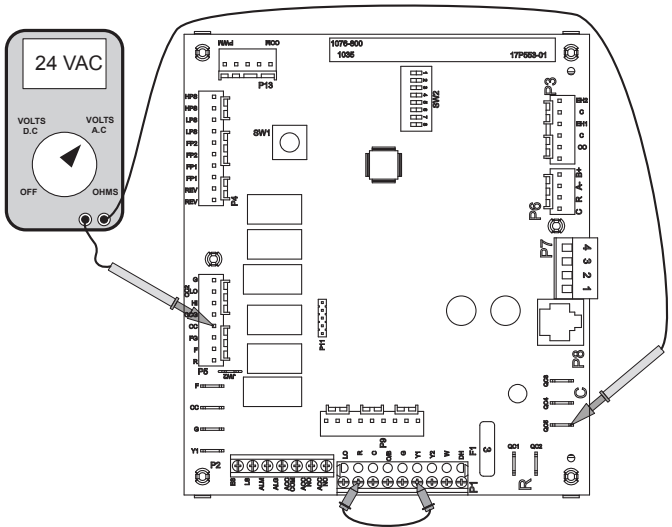

With the AID Tool go to the “Thermostat Inputs” Menu under “Diagnostics” and over-ride the “Y1” input to ON. If an AID Tool is not available remove the P1 connector to disconnect the thermostat from the board and place a jumper wire between “R” and “Y1” as shown. Apply power and put the board into test mode by holding SW1 for 2-5 seconds, the green LED will begin a slow flash. Connect your Volt meter leads to “CC” and “C”. After 1 minute the reading should be between 18 and 30VAC. If you have

a signal and the contactor is not pulled in, check voltage across the contactor coil. If you have voltage across the contractor coil, replace the contactor. If there is no voltage across the contactor coil, verify all wiring between the board and contactor. If you have no voltage between CC and C and the fault LED is not flashing, then replace the board.

### To Check Operation of the Reversing Valve Output

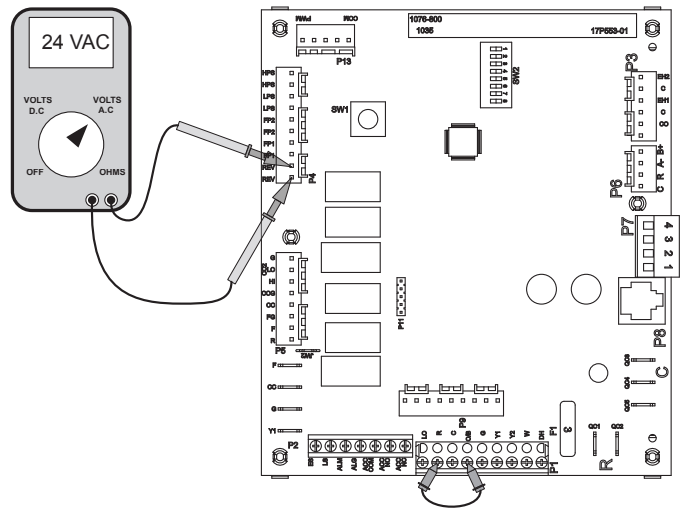

Make sure that SW2-3 is set to “ON”. With the AID Tool go to the “Thermostat Inputs” Menu under “Diagnostics” and over-ride the “O” input to ON. If an AID Tool is not available remove the P1 connector to disconnect the thermostat from the board and place a jumper wire between “R” and “O” as shown. Apply power and put the board into test mode by holding SW1 for 2-5 seconds, the green LED will begin a slow flash. Connect your Volt meter leads to the two “REV” pins on P4. The reading should be between 18 and 30VAC. If you have voltage and the reversing valve is not shifting, check voltage across the coil. If you have voltage across the reversing valve coil, but the valve does not shift the reversing valve coil may be bad. If there is no voltage across the coil, verify all wiring between the board and reversing valve. If no voltage is present on the two REV terminals then replace the board.

## Control Board Signals cont.

### To Check Operation of the Accessory Relay

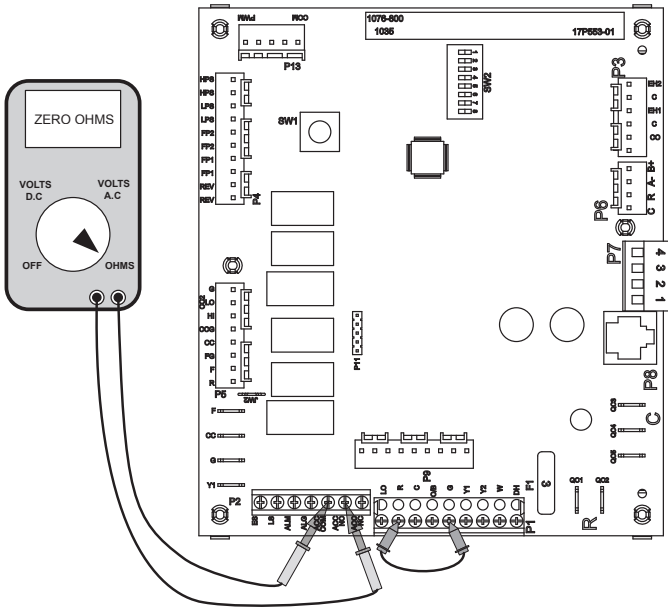

Make sure that SW2-4 and SW2-5 are both set to “ON”. With the AID Tool go to the “Thermostat Inputs” Menu under “Diagnostics” and over-ride the “G” input to ON. If an AID Tool is not available remove the P1 connector to disconnect the thermostat from the board and place a jumper wire between “R” and “G” as shown. Apply power and put the board into test mode by holding SW1 for 2-5 seconds, the green LED will begin a slow flash. Connect your Ohm meter leads to the two “ACC COM” and “ACC NO” on P2. A reading of zero ohms indicates that the relay is switching and operating normally. A reading of infinity or open line indicates that the relay did not close and the board should be replaced.

### To Bypass the Safety Circuit and Engage the Compressor Contactor

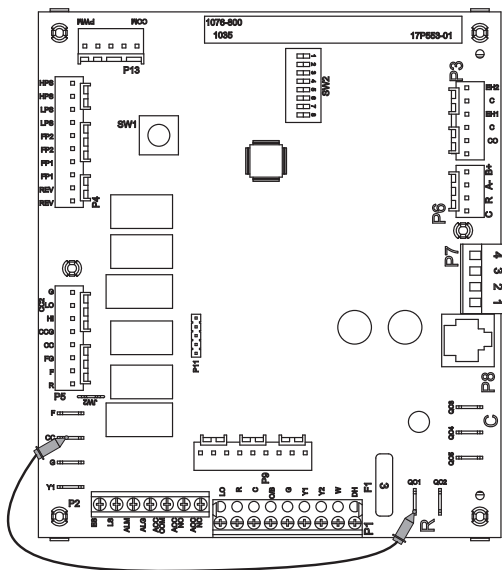

Put gauges on the unit to monitor high/low pressure. Place a jumper between “R” and “CC” as shown. **This will bypass the safety circuit and the compressor will run whether the board is calling for it or not.**

### To Check the Freeze Detection Thermistor (AID Tool Required)

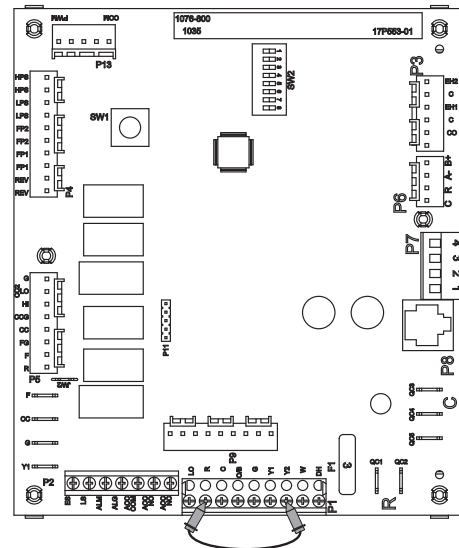

Disconnect the loop pumps so they will not run. Place a thermocouple on the refrigerant line next to the freeze detection thermistor. With the AID Tool go to the “Thermostat Inputs” Menu under “Diagnostics” and over-ride the “Y2” input to ON. If an AID Tool is not available remove the plug on P1 to disconnect the thermostat from the board. Place a jumper on “R” and “Y2” as shown. Apply power and put the board into test mode by holding SW1 for 2-5 seconds, the green LED will begin a slow flash. As the unit runs in second stage heating with the loop pump(s) not working, the lack of water flow will quickly bring down the temperature of the refrigerant line where the freeze detection thermistor is located. Watch the FP1 temperature reading on the AID Tool and compare it with the thermocouple reading. The thermocouple reading and FP1 reading should be within 2 degrees F of each other. If the thermistor is found to be out of calibration, replace the thermistor. Allowing the unit to continue to run will cause a freeze detection fault to occur. Remember, there is a two minute bypass delay and a 30 second recognition delay on the freeze detection input. This means that the compressor will not shut down during the first 2.5 minutes of run time regardless of how low the freeze thermistor reads.

Other items to check when troubleshooting a freeze detection lockout are superheat, water flow through the coaxial heat exchanger, and antifreeze composition. High superheat in heating will lower the refrigerant line temperature where the freeze protection thermistor is located. In this case, check the TXV. Closed loop systems are rated at 3 gpm/ton. If a closed loop system is running at less than 3 gpm/ton, the temperature difference between the refrigerant line and the actual leaving water temperature will be greater and could lead to possible freeze detection lockouts.

## Control Board Signals cont.

### To Check the Condensate Sensor

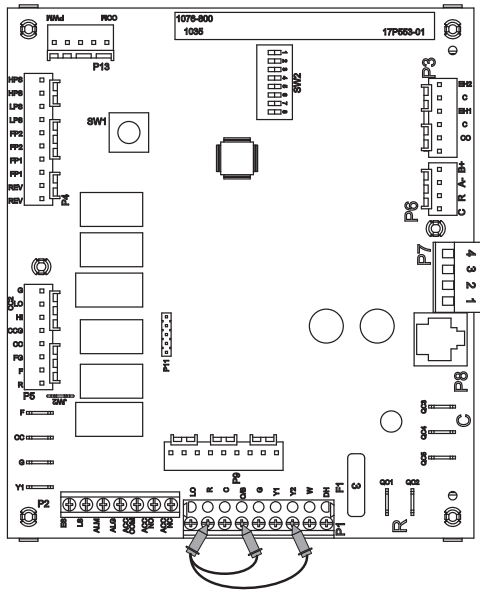

How it works: The condensate sensor is a three part system: a wire, air coil, and water in the drain pan. The wire (spade terminal) and air coil act like a normally open contact and the water acts as the switch. When water in the drain pan fills up and touches the spade terminal, the unit will fault on condensate.

Checking the Sensor: With the AID Tool go to the “Thermostat Inputs” Menu under “Diagnostics” and over-ride the “O” and “Y2” inputs to ON. If an AID Tool is not available remove the P1 connector to disconnect the thermostat from the board and place a jumper wire between “R”, “Y2”, and “O” as shown. Apply power and put the board into test mode by holding SW1 for 2-5 seconds, the green LED will begin a slow flash. Observe the water level in the drain pan. If the unit is locking out on condensate and the drain pan is dry, remove the condensate wire from the drain pan and tape it out of the way. Be careful not to ground the wire out because that will cause the unit to lockout on condensate over flow. If the unit is still locking out, check the brown wire all the way back to the logic board for a short to ground. Remember that the condensate sensor is just a wire looking for a ground. If it touches any metal in the cabinet, the unit will see that as a condensate fault.

If removing the wire from the drain pan stopped the false drain lockouts, put the condensate sensor back in place in the drain pan. Pay close attention to how far the spade terminal sits down in the drain pan. If the terminal is pushed all the way down so that it is touching the bottom of the drain pan, this will cause a condensate lockout if there is any trace of water in the drain pan. If the spade terminal fits loosely in the drain pan, spread the terminal open to make it fit snugly in the drain pan.

### To Check the ECM Blower Motor Enable Signal

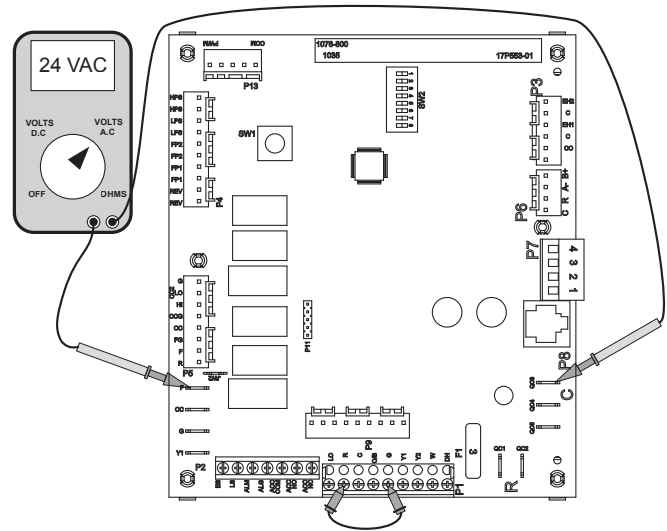

With the AID Tool go to the “Thermostat Inputs” Menu under “Diagnostics” and over-ride the “G” input to ON. If an AID Tool is not available remove the P1 connector to disconnect the thermostat from the board and place a jumper between “R” and “G” as shown. Put the board into test mode by holding SW1 for 2-5 seconds. The blower will come on and run in the “G” speed setting. To check the enable signal to the motor, measure 24VAC between the F and C terminals.

### To Check the Electric Heat Outputs

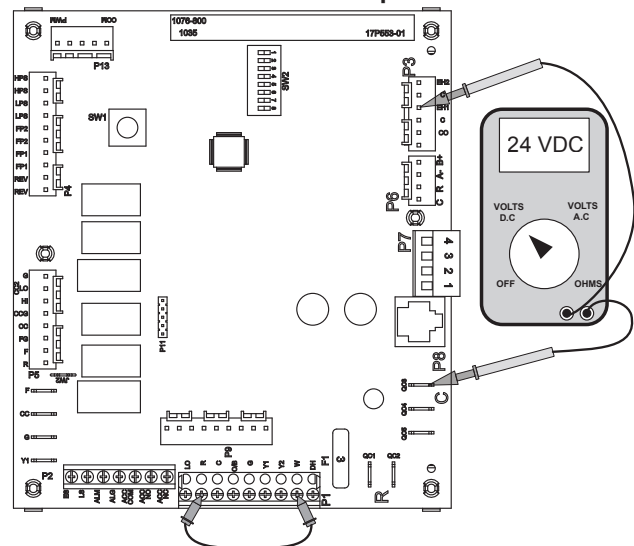

With the AID Tool go to the “Thermostat Inputs” Menu under “Diagnostics” and over-ride the “W” input to ON. If an AID Tool is not available remove the P1 connector to disconnect the thermostat from the board and place a jumper between “R” and “W” as shown. Put the board into test mode by holding SW1 for 2-5 seconds. The blower will come on and run in high speed. 10 seconds later electric heat output 1 (EH1) will be enabled followed by electric heat output 2 (EH2) in 7.5 seconds. Check EH1 by measuring DC volts between “C” and “EH1” and check EH2 by measuring DC volts between “C” and “EH2”.



# Jumping the Control Board

## Stage 1 Heating

With the AID Tool go to the “Thermostat Inputs” Menu under “Diagnostics” and over-ride the “Y1” input to ON. If an AID Tool is not available remove the P1 connector to disconnect the thermostat from the board. Place a jumper between the “R” and “Y1” terminals as shown.

The blower motor will start in “G” blower speed setting immediately the compressor will start 10 seconds later. If the unit is equipped with an ECM blower motor it will switch to low speed 15 seconds after the Y1 input.

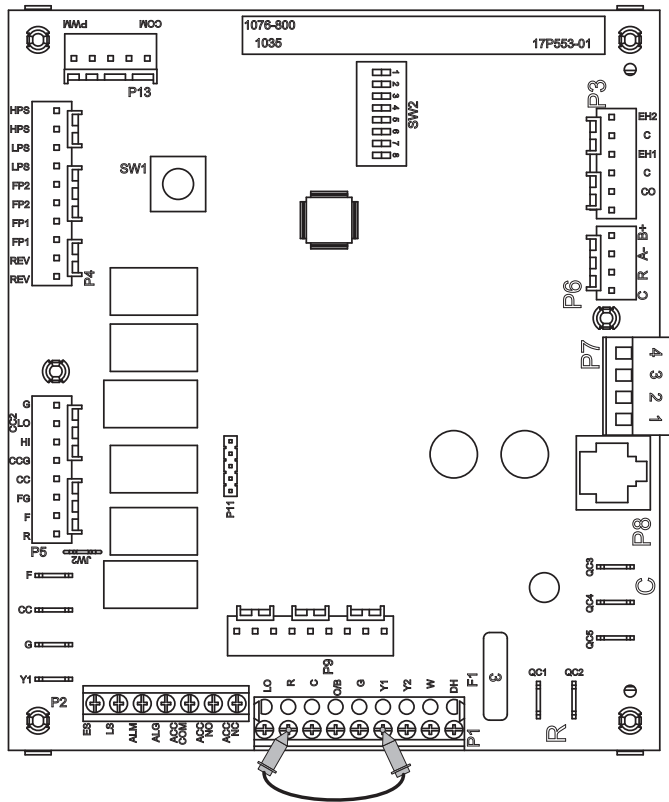

## Stage 2 Heating

With the AID Tool go to the “Thermostat Inputs” Menu under “Diagnostics” and over-ride the “Y1” and “Y2” inputs to ON. If an AID Tool is not available remove the P1 connector to disconnect the thermostat from the board. Place a jumper between the R, Y1, and Y2 terminals as shown.

The blower motor will start in “G” blower speed setting immediately the compressor will start 10 seconds later. If the unit is equipped with an ECM blower motor it will switch to low speed 15 seconds after the Y1 input. The compressor will stage to full capacity 20 seconds after the compressor starts, and the blower will change to high speed.

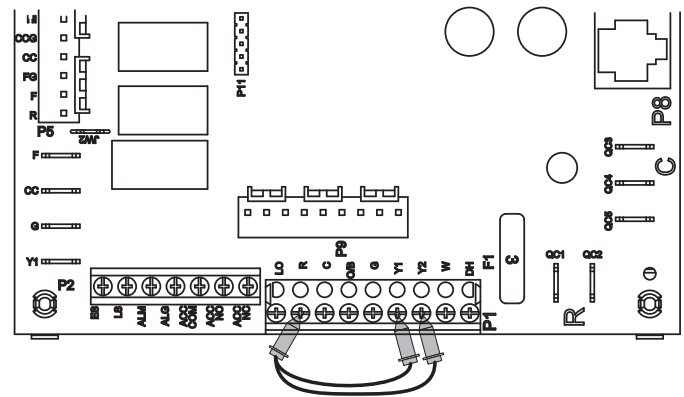

## Stage 3 Heating

With the AID Tool go to the “Thermostat Inputs” Menu under “Diagnostics” and over-ride the “Y1”, “Y2”, and “W” inputs to ON. If an AID Tool is not available remove the P1 connector to disconnect the thermostat from the board. Place a jumper between the R, Y1, Y2 and W terminals as shown.

The blower motor will start in “G” blower speed setting immediately the compressor will start 10 seconds later. If the unit is equipped with an ECM blower motor it will switch to low speed 15 seconds after the Y1 input. The compressor will stage to full capacity 20 seconds after the compressor starts, and the blower will change to high speed. The first stage of resistance heat is energized and with continuous third stage demand the second stage of resistance heat will engage in 5 minutes.

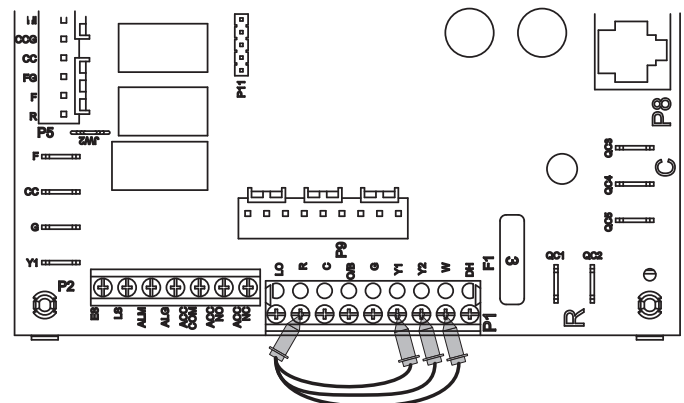

# Jumping the Control Board cont.

## Emergency Heat

With the AID Tool go to the “Thermostat Inputs” Menu under “Diagnostics” and over-ride the “W” input to ON. If an AID Tool is not available remove the P1 connector to disconnect the thermostat from the board. Place a jumper between the “R” and “W” terminals as shown.

The blower will start on high speed and after 20 seconds the first stage of resistance heat is energized. Continuing demand will engage the second stage after 2 minutes.

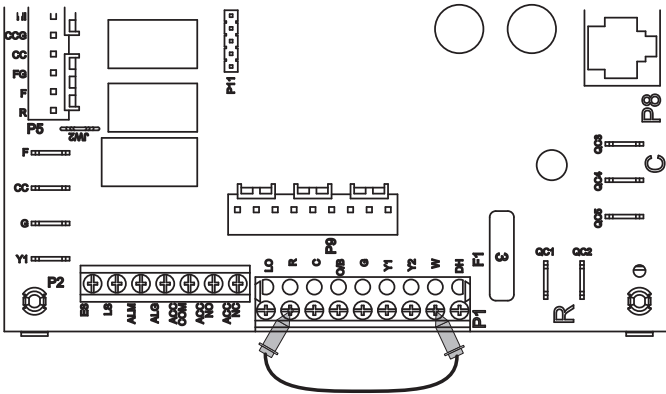

## Stage 1 Cooling

With the AID Tool go to the “Thermostat Inputs” Menu under “Diagnostics” and over-ride the “Y1” and “O” inputs to ON. If an AID Tool is not available remove the P1 connector to disconnect the thermostat from the board. Place a jumper between the R, O, and Y1 terminals as shown.

The blower motor will start in “G” blower speed setting immediately, the compressor will start 10 seconds later. If the unit is equipped with an ECM blower motor it will switch to low speed 15 seconds after the Y1 input.

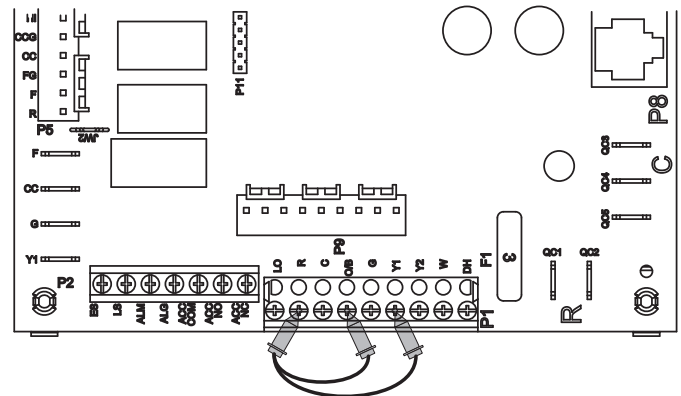

## Blower Only

With the AID Tool go to the “Thermostat Inputs” Menu under “Diagnostics” and over-ride the “G” input to ON. If an AID Tool is not available remove the P1 connector to disconnect the thermostat from the board. Place a jumper between the “R” and “G” terminals as shown.

The blower will start on the “G” speed setting. Also, regardless of blower speed setting, the blower will remain on for 30 seconds at the end of each heating, cooling, emergency heat, or reheat cycle.

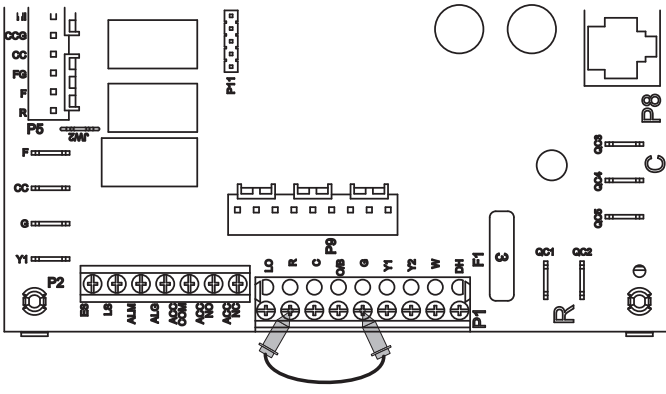

## Stage 2 Cooling

With the AID Tool go to the “Thermostat Inputs” Menu under “Diagnostics” and over-ride the “Y1”, “Y2”, and “O” inputs to ON. If an AID Tool is not available remove the P1 connector to disconnect the thermostat from the board. Place a jumper between the R, O, Y1, and Y2 terminals as shown.

The blower motor will start in “G” blower speed setting immediately the compressor will start 10 seconds later. If the unit is equipped with an ECM blower motor it will switch to low speed 15 seconds after the Y1 input. The compressor will stage to full capacity 20 seconds after the compressor starts, and the blower will change to high speed.

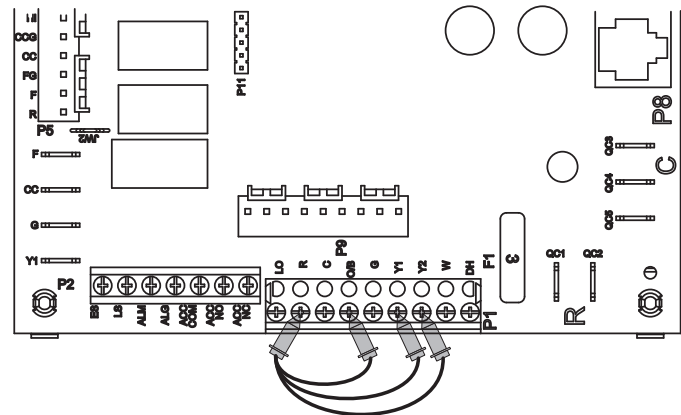

## Jumping the Control Board cont.

### Reheat Mode

With the AID Tool go to the “Thermostat Inputs” Menu under “Diagnostics” and over-ride the “DH” input to ON. If an AID Tool is not available remove the P1 connector to disconnect the thermostat from the board. Place a jumper between the R and DH terminals as shown.

The blower motor will start in “G” blower speed setting immediately the compressor will start 10 seconds later. If the unit is equipped with an ECM blower motor it will switch to low speed 15 seconds after the DH input. 20 seconds after the DH input is received the compressor will switch to full capacity and the blower motor will switch to dehumidification high speed. 30 seconds after the compressor starts the alarm/reheat output will energize.

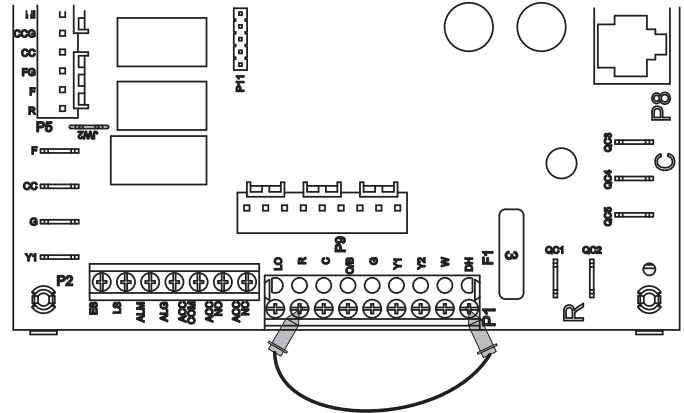

## Preventative Maintenance

### Water Coil Maintenance

1. Keep all air out of the water. An open loop system should be checked to ensure that the well head is not allowing air to infiltrate the water line. Lines should always be airtight.
2. Keep the system under pressure at all times. It is recommended in open loop systems that the water control valve be placed in the discharge line to prevent loss of pressure during off cycles. Closed loop systems must have positive static pressure.

**NOTE:** On open loop systems, if the installation is in an area with a known high mineral content (125 PPM or greater) in the water, it is best to establish with the owner a periodic maintenance schedule so the coil can be checked regularly. Should periodic coil cleaning be necessary, use standard coil cleaning procedures which are compatible with either the cupronickel or copper water lines. Generally, the more water flowing through the unit the less chance for scaling.

### Other Maintenance

#### Filters

Filters must be clean to obtain maximum performance. They should be inspected monthly under normal operating conditions and be replaced when necessary. Units should never be operated without a filter.

#### Condensate Drain

In areas where airborne bacteria produce a slime in the drain pan, it may be necessary to treat chemically to minimize the problem. The condensate drain can pick up lint and dirt, especially with dirty filters. Inspect twice a year to avoid the possibility of overflow.

#### Blower Motors

Blower motors are equipped with sealed ball bearings and require no periodic oiling.

#### Air Coil

The air coil must be cleaned to obtain maximum performance. Check once a year under normal operating conditions and, if dirty, brush or vacuum (with a brush attachment) clean. Care must be taken not to damage the aluminum fins while cleaning.



**CAUTION: Fin edges are sharp.**

## Replacement Procedures

### Obtaining Parts

When ordering service or replacement parts, refer to the model number and serial number of the unit as stamped on the serial plate attached to the unit. If replacement parts are required, mention the date of installation of the unit and the date of failure, along with an explanation of the malfunctions and a description of the replacement parts required.

### In-Warranty Material Return

Material may not be returned except by permission of authorized warranty personnel. Contact your local distributor for warranty return authorization and assistance.

## Troubleshooting

Should a major problem develop, refer to the following information for possible causes and corrective steps.

### If compressor won't run:

1. The fuse may be open or the circuit breaker is tripped. Check electrical circuits and motor windings for shorts or grounds. Investigate for possible overloading. Replace fuse or reset circuit breakers after fault is corrected.
2. Supply voltage may be too low. Check it with a volt meter.
3. Control system may be faulty. Check control for correct wiring of thermostat or aquastat and check the 24 volt transformer for proper voltage.
4. Wires may be loose or broken. Replace or tighten.
5. The low pressure switch may have tripped due to one or more of the following:
  - a) Heating
    - 1) Plugged heat exchanger on source side
    - 2) Water flow source side - (Low)
    - 3) Water too cold source side
    - 4) Low refrigerant
  - b) Cooling
    - 1) Plugged heat exchanger on load side
    - 2) Water flow load side - (Low)
    - 3) Water too cold load side
    - 4) Low refrigerant
6. The high pressure switch may have tripped due to one or more of the following:
  - a) Heating
    - 1) Plugged heat exchanger on load side
    - 2) Low water flow load side
    - 3) Water too warm load side
  - b) Cooling
    - 1) Plugged heat exchanger on source side
    - 2) Low water flow on source side
    - 3) Water too warm source side
7. The compressor overload protection may be open.
8. The internal winding of the compressor motor may be grounded to the compressor shell. If so, replace the compressor.
9. The compressor winding may be open or shorted. Disconnect power. Check continuity with ohm meter. If the winding is open, replace the compressor.

### If sufficient cooling or heating is not obtained:

1. Check control for improper location or setting.
2. Check for restriction in water flow.
3. Check refrigerant subcooling and superheat for proper refrigerant charge and expansion valve operation.
4. The reversing valve may be defective and creating a bypass of refrigerant. If the unit will not heat, check the reversing valve coil.

### If the unit operation is noisy:

1. Check compressor for loosened mounting bolts. Make sure compressor is floating free on its isolator mounts. Check for tubing contact with the compressor or other surfaces. Readjust it by bending slightly.
2. Check screws on all panels.
3. Check for chattering or humming in the contactor or relays due to low voltage or a defective holding coil. Replace the component.
4. Check for proper installation of vibration absorbing material under the unit.
5. Check for abnormally high discharge pressures.
6. Compressor rotation incorrect

## Refrigerant Systems

To maintain sealed circuit integrity, do not install service gauges unless unit operation appears abnormal. Compare the change in temperature on the air side as well as the water side to the Operating Parameters tables. If the unit's performance is not within the ranges listed, and the airflow and water flow are known to be correct, gauges should then be installed and superheat and subcooling numbers calculated. If superheat and subcooling are outside recommended ranges, an adjustment to the refrigerant charge may be necessary.

**NOTE:** Refrigerant tests must be made with hot water generator turned "OFF". Verify that air and water flow rates are at proper levels before servicing the refrigerant circuit.

# Troubleshooting Checklist

Company Name: \_\_\_\_\_ Company Phone No: \_\_\_\_\_  
 Technician Name: \_\_\_\_\_ Date: \_\_\_\_\_  
 Model No: \_\_\_\_\_ Serial No: \_\_\_\_\_  
 Owner's Name: \_\_\_\_\_ Open or Closed Loop: \_\_\_\_\_  
 Installation Address: \_\_\_\_\_ Installation Date: \_\_\_\_\_

Check One

Start up/Check-out for new installation       Troubleshooting      Problem: \_\_\_\_\_

1. FLOW RATE IN GPM (COAXIAL HEAT EXCHANGER)

Water In Pressure:                      a. \_\_\_\_\_ PSI  
 Water Out Pressure:                    b. \_\_\_\_\_ PSI  
 Pressure Drop = a - b                    c. \_\_\_\_\_ PSI  
 Convert Pressure Drop to Flow Rate  
 (refer to *Pressure Drop* table)              d. \_\_\_\_\_ GPM

2. TEMPERATURE RISE OR DROP ACROSS COAXIAL HEAT EXCHANGER

	COOLING	HEATING
Water In Temperature:	e. _____ °F	e. _____ °F
Water Out Temperature:	f. _____ °F	f. _____ °F
Temperature Difference:	g. _____ °F	g. _____ °F

3. TEMPERATURE RISE OR DROP ACROSS AIR COIL

	COOLING	HEATING
Air In Temperature:	h. _____ °F	h. _____ °F
Air Out Temperature:	i. _____ °F	i. _____ °F
Temperature Difference:	j. _____ °F	j. _____ °F

4. HEAT OF REJECTION (HR) / HEAT OF EXTRACTION (HE) CALCULATION

HR or HE = Flow Rate x Temperature Difference x Brine Factor\*  
 d. (above) x g. (above) x 485 for Methanol or Environol, 500 for water\*  
 Heat of Extraction (Heating Mode) = \_\_\_\_\_ btu/hr  
 Heat of Rejection (Cooling Mode) = \_\_\_\_\_ btu/hr  
 Compare results to Capacity Data Tables

Note: Steps 5 through 8 need only be completed if a problem is suspected

5. WATTS

	COOLING	HEATING
Volts:	m. _____ VOLTS	m. _____ VOLTS
Total Amps (Comp. + Fan):	n. _____ AMPS	n. _____ AMPS
Watts = m. x n. x 0.85	o. _____ WATTS	o. _____ WATTS

6. CAPACITY

Cooling Capacity = HR. - (o. x 3.413)                      p. \_\_\_\_\_ btu/hr  
 Heating Capacity = HE. + (o. x 3.413)                      p. \_\_\_\_\_ btu/hr

7. EFFICIENCY

Cooling EER = p. / o.    q. \_\_\_\_\_ EER  
 Heating COP = p. / (o. x 3.413)                              q. \_\_\_\_\_ COP

8. SUPERHEAT (S.H.) / SUBCOOLING (S.C.)

	COOLING	HEATING
Suction Pressure:	r. _____ PSI	r. _____ PSI
Suction Saturation Temperature:	s. _____ °F	s. _____ °F
Suction Line Temperature:	t. _____ °F	t. _____ °F
Superheat = t. - s.	u. _____ °F	u. _____ °F
Head Pressure:	v. _____ PSI	v. _____ PSI
High Pressure Saturation Temp.:	w. _____ °F	w. _____ °F
Liquid Line Temperature*:	x. _____ °F	x. _____ °F
Subcooling = w. - x.	y. _____ °F	y. _____ °F

\* Note: Liquid line is between the coaxial heat exchanger and the expansion valve in the cooling mode; between the air coil and the expansion valve in the heating mode.

## Decommissioning

Before carrying out this procedure, it is essential that the technician is completely familiar with the equipment and all its detail. It is recommended good practice that all refrigerants are recovered safely. Prior to the task being carried out, an oil and refrigerant sample shall be taken in case analysis is required prior to re-use of recovered refrigerant. It is essential that electrical power is available before the task is commenced.

1. Become familiar with the equipment and its operation.
2. Isolate system electrically.
3. Before attempting the procedure, ensure that:
  - mechanical handling equipment is available, if required, for handling refrigerant cylinders;
  - all personal protective equipment is available and being used correctly;
  - the recovery process is supervised at all times by a competent person;
  - recovery equipment and cylinders conform to the appropriate standards.
4. Pump down refrigerant system, if possible.
5. If a vacuum is not possible, make a manifold so that refrigerant can be removed from various parts of the system.
6. Make sure that cylinder is situated on the scales before recovery takes place.
7. Start the recovery machine and operate in accordance with instructions.
8. Do not overfill cylinders (no more than 80 % volume liquid charge).
9. Do not exceed the maximum working pressure of the cylinder, even temporarily.
10. When the cylinders have been filled correctly and the process completed, make sure that the cylinders and the equipment are removed from site promptly and all isolation valves on the equipment are closed off.
11. Recovered refrigerant shall not be charged into another REFRIGERATING SYSTEM unless it has been cleaned and checked

## Decommissioning - Unit Labeling Requirements

Equipment shall be labelled stating that it has been de-commissioned and emptied of refrigerant. The label shall be dated and signed. For appliances containing FLAMMABLE REFRIGERANTS, ensure that there are labels on the equipment stating the equipment contains FLAMMABLE REFRIGERANT.

## Refrigerant Recovery

When removing refrigerant from a system, either for servicing or decommissioning, it is recommended good practice that all refrigerants are removed safely.

When transferring refrigerant into cylinders, ensure that only appropriate refrigerant recovery cylinders are employed. Ensure that the correct number of cylinders for holding the total system charge is available. All cylinders to be used are designated for the recovered refrigerant and labelled for that refrigerant (i.e. special cylinders for the recovery of refrigerant). Cylinders shall be complete with pressure-relief valve and associated shut-off valves in good working order. Empty recovery cylinders are evacuated and, if possible, cooled before recovery occurs.

The recovery equipment shall be in good working order with a set of instructions concerning the equipment that is at hand and shall be suitable for the recovery of the flammable refrigerant. If in doubt, the manufacturer should be consulted. In addition, a set of calibrated weighing scales shall be available and in good working order. Hoses shall be complete with leak-free disconnect couplings and in good condition.

The recovered refrigerant shall be processed according to local legislation in the correct recovery cylinder, and the relevant waste transfer note arranged. Do not mix refrigerants in recovery units and especially not in cylinders.

If compressors or compressor oils are to be removed, ensure that they have been evacuated to an acceptable level to make certain that flammable refrigerant does not remain within the lubricant. The compressor body shall not be heated by an open flame or other ignition sources to accelerate this process. When oil is drained from a system, it shall be carried out safely.

## Refrigerant Removal and Evacuation

When breaking into the refrigerant circuit to make repairs – or for any other purpose conventional procedures shall be used. However, for flammable refrigerants it is important that best practice be followed, since flammability is a consideration. The following procedure shall be adhered to:

- safely remove refrigerant following local and national regulations;
- evacuate;
- purge the circuit with inert gas (optional for A2L);
- evacuate (optional for A2L);
- continuously flush or purge with inert gas when using flame to open circuit; and
- open the circuit.

The refrigerant charge shall be recovered into the correct recovery cylinders if venting is not allowed by local and national codes. For appliances containing flammable refrigerants, the system shall be purged with oxygen-free nitrogen to render the appliance safe for flammable refrigerants.

This process might need to be repeated several times. Compressed air or oxygen shall not be used for purging refrigerant systems. For appliances containing flammable refrigerants, refrigerants purging shall be achieved by breaking the vacuum in the system with oxygen-free nitrogen and continuing to fill until the working pressure is achieved, then venting to atmosphere, and finally pulling down to a vacuum (optional for A2L). This process shall be repeated until no refrigerant is within the system (optional for A2L). When the final oxygen-free nitrogen charge is used, the system shall be vented down to atmospheric pressure to enable work to take place. The outlet for the vacuum pump shall not be close to any potential ignition sources, and ventilation shall be available.



## Charging procedures

In addition to conventional charging procedures, the following requirements shall be followed.

- Ensure that contamination of different refrigerants does not occur when using charging equipment.
- Hoses or lines shall be as short as possible to minimise the amount of refrigerant contained in them.
- Cylinders shall be kept in an appropriate position according to the instructions.
- Ensure that the REFRIGERATING SYSTEM is earthed prior to charging the system with refrigerant.
- Label the system when charging is complete (if not already).
- Extreme care shall be taken not to overfill the REFRIGERATING SYSTEM.

Prior to recharging the system, it shall be pressure-tested with the appropriate purging gas. The system shall be leak-tested on completion of charging but prior to commissioning. A follow up leak test shall be carried out prior to leaving the site.

## Notes

## Revision Guide

<b>Pages:</b>	<b>Description:</b>	<b>Date:</b>	<b>By:</b>
All	Document Creation	29 Aug 2024	SW
6	Nomenclature update	25 Oct 2024	SW
7-8	Update AHRI Data	7 Jan 2025	SW
19	Update Electrical Data	7 Jan 2025	SW
20	Add Fuse Replacement	28 Jan 2025	SW
44	Update Compressor Resistance	24 Feb 2025	SW
2	Add Freeze Protection Warning	24 Feb 2025	SW
24,31,32,37	Notation on UPC as optional accessory on certain models	10 April 2025	SW



Product: Affinity **YDL Series**  
Type: Geothermal/Water Source Heat Pumps  
Size: 7-30 Ton

Document Type: Operation & Maintenance Manual  
Part Number: OMV5-0005Y  
Release Date: 04/25

©2025 The manufacturer has a policy of continual product research and development and reserves the right to change design and specifications without notice.

York and Affinity are registered trademarks of Johnson Controls, Inc., and are used with permission.